

No. 043007-13

BMW F20 Bj. 03.14-

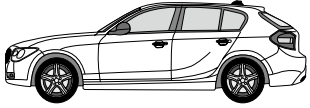

BMW F21 Bj. 03.14-

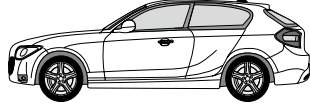

BMW F22 Bj. 03.14-



BMW F23 Bj. 03.15-

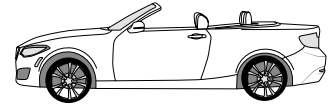

BMW F30 Bj. 03.14-



BMW F31 Bj. 03.14-

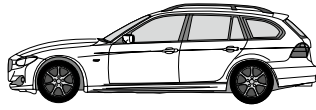

BMW F32 Bj. 03.14-

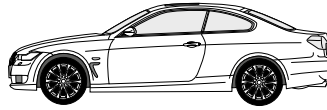

BMW F33 Bj. 03.14-

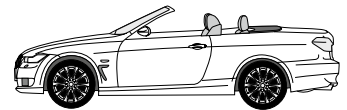

BMW F34 Bj. 03.14-

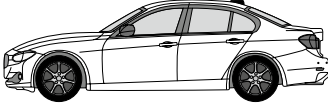

BMW F36 Bj. 03.14-

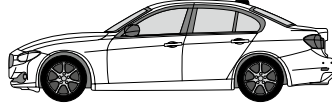

BMW F07 Bj. 01.14-



BMW F10 Bj. 03.14-

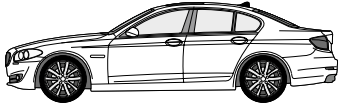

BMW F11 Bj. 03.14-

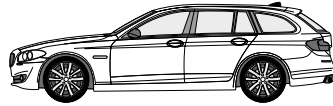

BMW F01/F02 Bj. 03.14-

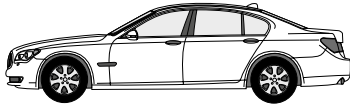

BMW X3 (F25) Bj. 03.14-

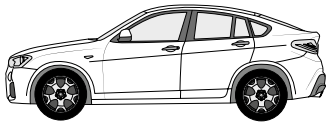

BMW X4 (F26) Bj. 07.14-

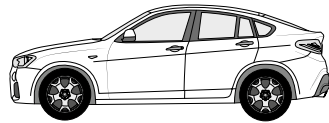

BMW X5 (F15) Bj. 11.13 -



BMW X6 (F16) Bj. 12.14 -



KIT 043007



KIT 043013

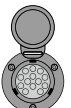

(D)!

Der Einbau dieses Elektrosatzes muß von einer Fachwerkstatt oder einer entsprechend qualifizierten Person durchgeführt werden. Vor Beginn aller Montagearbeiten unbedingt die Einbauanleitung komplett durchlesen. Nach Einbau des Elektrosatzes ist die Einbauanleitung den Serviceunterlagen des Fahrzeuges beizulegen!

Bei unsachgemäßer Anwendung oder Veränderung des Elektrosatzes bzw. der darin befindlichen Bauteile erlischt jeder Anspruch auf Gewährleistung. Beim Fahren ohne Anhänger oder Ladungsträger müssen ggf. verwendete Adapter immer aus der Steckdose entfernt werden. Änderungen bezüglich Konstruktion, Ausstattung, Farbe sowie Irrtum vorbehalten. Alle Angaben und Abbildungen unverbindlich.

Bei Anhängern ohne Nebelschlussleuchte sollte diese nachgerüstet werden.

Für technische bzw. elektronische Änderungen, welche nach erstmaliger Inbetriebnahme des Elektrosatzes vom Fahrzeughersteller durchgeführt werden und beispielsweise zu Fehlfunktionen der Anhängersteckdose oder deren Peripherie führen, übernehmen wir keinerlei Gewährleistung!

Das Anhängermodul ist nicht diagnosefähig! Sollten herstellerseitige Diagnoseprozesse bzw. softwaregestützte Prüfmechanismen Fehlerprotokolle generieren, welche direkt oder indirekt mit Anhängerbetrieb in Zusammenhang stehen, ist das Anhängermodul vom Leitungssatz für die Anhängersteckdose zu trennen und ein nochmaliger Diagnosevorgang zu starten!

(GB)!

Installation of the towing electrics kit must be undertaken by a specialist workshop or an appropriately qualified person. Before starting work, you must read the installation instructions through completely. After installing the towing electrics kit, the installation instructions should be kept with the vehicle service documentation.

All claims under the guarantee will lapse in case of improper use or modification of the towing electrics kit or any of its component parts. When driving without a trailer or load carrier, any adapter installed must be removed from the electrical socket. We reserve the right to alter the design, content or colour. We accept no liability for any errors in these instructions. All details and illustrations are non-binding.

In case of missing a rear fog lamp on the trailer, it should be retrofitted. We accept no responsibility and give no guarantee for technical and electrical modifications made after the initial operation of the towing electrics kit by the vehicle manufacturer and which may lead, for example to malfunction of the trailer socket or its peripheries.

The trailer module is not diagnostics-capable. If the manufacturer's diagnostics processes or software-supported test mechanisms generate error reports directly or indirectly linked with trailer operation, the trailer module must be disconnected from the leads to the trailer socket and a new diagnostic process initiated.

(F)!

Le montage du kit de connexion électrique doit être effectué par un atelier spécialisé ou par une personne qualifiée en matière. Avant le début des travaux, lire impérativement les instructions de montage dans leur intégralité. Après le montage du kit de connexion électrique, joindre les instructions de montage aux documents du véhicule.

Un usage inapproprié ou des modifications du kit de connexion électrique, ou des pièces qui le composent, entraînent l'expiration de tout droit à la garantie. Lors d'une conduite sans remorque ou porteur de charge, les adaptateurs utilisés doivent, le cas échéant, toujours être enlevés de la prise de courant. Sous réserve de modifications de constructions, équipement, couleurs ou erreur. Données et illustrations sous réserve.

Pour les remorques qui ne sont pas équipées avec feux anti-brouillard arrière, il devrait être installé.

Nous n'assumons aucune responsabilité ni garantie pour les modifications techniques et électroniques ayant été effectuées après la première mise en service du kit de connexion électrique par le constructeur automobile et ayant mené par exemple à des mauvais fonctionnements de la prise de remorque ou de sa périphérie.

Le module remorque ne contient pas de fonction diagnostic! Au cas où des processus de diagnostic définis par le fabricant ou des mécanismes de contrôle assistés par ordinateur devaient générer des messages d'erreur directement ou indirectement en rapport avec le fonctionnement de la remorque, il est impératif pour la prise de remorque de détacher le module remorque du groupe électrique et d'initier une nouvelle procédure de diagnostic.

(NL)!

De inbouw van deze elektroset moet door een vakwerkplaats of dooreen overeenkomstig gekwalificeerde persoon gebeuren. Vóór aanvang van alle montagewerkzaamheden absoluut de montagehandleiding volledig doorlezen. Na inbouw van de elektroset dient de montagehandleiding bij de servicedocumenten van het voertuig te worden gelegd!

Bij ondeskundige toepassing of wijziging van de elektroset c.q. van de daarin zittende componenten vervalt elke aanspraak op fabrieksgarantie. Tijdens het rijden zonder aanhanger of ladingdrager moeten evt. gebruikte adapters altijd uit de stekkerdoos worden verwijderd. Wijzigingen met betrekking tot constructie, uitvoering, kleur alsmede vergissing voorbehouden. Alle opgaven en afbeeldingen niet-bindend.

Bij aanhangers zonder mistachterlicht dient dit achteraf te worden gemonteerd.

Wij verlenen geen fabrieksgarantie voor technische c.q. elektronische wijzigingen die na de eerste inbedrijfstelling van de elektroset door de voertuigfabrikant worden uitgevoerd en bijvoorbeeld leiden tot foutieve functies van de stekkerdoos van de aanhanger of diens periferie!

De aanhangermodule kan niet worden gediagnosticeerd! Mochten diagnoseprocessen van de kant van de fabrikant c.q. op software steunende testmechanismen foutprotocollen genereren die direct of indirect in verband staan met het gebruik van de aanhanger, dan dient de aanhangermodule te worden losgekoppeld van de kabelset voor de aanhangersteckerdoos en dient het diagnoseproces nogmaals te worden gestart!

(DK)!

Installering af det elektriske udstyr skal udføres af et specialværksted eller af en dertil uddannet person. Før påbegyndelse af montagearbejdet bør man læse grundigt hele montagevejledningen. Efter installering af det elektriske udstyr skal montagevejledningen vedlægges bilens servicedokumentation.

Ved et ukorrekt brug eller foretagelse af ændringer i det elektriske udstyr eller udskiftning af udstyrets enkelte bestanddele bortfalder alle garantiretigheder. Ved kørsel uden påhængsvogn eller en anden bæreanordning skal de anvendte tilkoblingsstykker kobles fra strømkontakter. Vi forbeholder os ret til indføring af konstruktionsændringer samt ændringer af indretning og farve, og derudover ret til det, at der i betjeningsvejledninger kan forekomme fejlinformationer. Alle informationer, data og illustrationer er ikke bindende.

Ved påhængsvogne uden tågelys skal man forsyne påhængsvogn med tågelys.

Vi frasiger os ethvert ansvar for de tekniske eller elektroniske ændringer foretaget af bilfabrikanten efter det elektriske udstyrs første igangsætning, hvor ændringerne kan eksempelvis medføre fejlfunktion i påhængsvognens kontakt eller dets periferianlæg!

Påhængsvognsmodulen er ikke tilpasset til gennemførelse af diagnostik! I det tilfælde, hvor diagnostiske processer gennemført af fabrikanten eller kontrolanordninger støttet med software fører til generering af fejlprotokoller, der står i et direkte eller indirekte sammenhæng med påhængsvognsdrift, skal påhængsmodulen kobles fra påhængsvognens ledningsbundt. Dernæst skal man igen gennemføre hele diagnostikproceduren!

(N)!

Montering av elektrisk utstyr må gjennomføres på et merkeverksted eller av kvalifisert fagperson. Før monteringsarbeidet tar til, må hele monteringsveiledningen leses. Etter montering av elektrisk utstyr, skal monteringsveiledning for service på kjøretøyet legges ved.

Ved ikke forskriftsmessig bruk eller forandring av elektrisk utstyr, evt. komponenter i dette, opphører alt garantiansvar. Ved kjøring uten tilhenger eller lasteholder må evt. egnet adapter alltid fjernes fra stikkontakten. Forbehold om endringer vedrørende konstruksjon, utrustning, farge så vel som mistak. Alle angivelser og illustrasjoner er uforpliktende.

Ved tilhenger uten tåkelys skal disse ettermonteres.

For tekniske, henholdsvis elektriske endringer, som er gjennomført etter første gangs igangkjøring av det elektriske utstyret av kjøretøyfabrikant og eksempelvis førte til feilfunksjon av tilhengerstikkontakt eller i nærheten av denne, påtar vi oss ikke garantiansvar!

Tilhengermodulen kan ikke utføre diagnose! Skulle diagnoseprosesser fra fabrikkens side, henholdsvis programvarestøttet prøvemekanisme generere feilprotokoll, som direkte eller indirekte har sammenheng med tilhengerfunksjonen, skal tilhengermodulen skilles fra ledningssettet i tilhengerstikkontakten og gjentatt diagnoseforløp skal startes!

(S)!

El-insatsen måste monteras av en specialistverkstad eller en person med motsvarande kvalifikationer. Innan monteringen påbörjas måste hela monteringsanvisningen läsas igenom. Sedan el-insatsen monterats bör monteringsanvisningen bifogas fordonets servicebok.

Används eller förändras el-insatsen eller någon av dess delar på ett icke fackmannamässigt sätt upphör alla garantianspråk. Vid färd utan släp måste eventuellt använda adaptrar tas ur uttaget. Vi förbehåller oss rätten till förändringar vad gäller konstruktion, färg samt misstag. Alla angivelser och avbildningar är icke bindande.

Släp utan dimbakljus borde kompletteras med sådana.

För tekniska resp. elektroniska ändringar, som utförs av fordonstillverkaren sedan el-insatsen tagits i bruk och t.ex. medför att släpvnagsdosan eller dosans periferi fungerar felaktigt lämnar vi ingen som helst garanti!

Släpvnagsmodulen kan inte diagnosticera! Om fordonstillverkarens diagnosprocesser resp. mjukvarustödda testmekanismer genererar felfunktionsrapporter som direkt eller indirekt har samband med släpvnagsdriften ska släpvnagsmodulen skiljas från släpvnagsdosans ledningar varpå en ny diagnos genomförs!

(FIN)!

Ammattityöpajän tai valtuutetun henkilön on hoidettava sähköosan asennus. Ennen kaiken asennustyön aloittamista on asennusohje ehdottomasti luettava kokonaan läpi. Sähköosan asennuksen jälkeen liitetään ajoneuvon asennusohje palvelulalistaan.

Aiheettoman käytön tai sähköosan ja siihen liittyvien osien muutosten seurauksena takuu raukeaa. Ajon aikana ilman perävaunua tai peräkärriä on käytettävän adapterin oltava aina kaukana pistokkeesta. Pidätämme oikeuden rakennetta koskeviin, varusteiden, värin sekä virheiden muutoksiin. Kaikki tiedot ja kuvat eivät ole yhdistettävissä.

Jos perävaunussa ei ole takasumuja, siihen tulisi asentaa ne.

Emme ota vastuuta mistään takuusta teknisiin tai sähköisiin muutoksiin, jotka ajoneuvon valmistaja suorittaa ensimmäistä kertaa sähköosan käyttöönotossa, emmekä esimerkiksi virhetoimintoista, joita perävaunun pistorasia tai oheislaite aiheuttaa!

Perävaununmoduuli ei ole diagnosikykyinen! Jos valmistusaikaiset diagnosiprosessit eli ohjelmistotuetut tarkistusmekanismit tuottavat virheprotokollia, jotka johdonmukaisesti liittyvät suoraan tai epäsuorasti yhteen perävaununkäytön kanssa, erotetaan perävaununmoduuli ohjausosasta perävaunupistokkeella ja aloitetaan diagnoositapaus uudelleen!

(I)!

L'installazione del kit elettrico deve essere effettuata da un'officina o da personale specializzato. Prima di iniziare tutti i lavori di montaggio, leggere da cima a fondo le istruzioni. Dopo aver installato il kit elettrico si prega di allegare le istruzioni di montaggio ai documenti di manutenzione del veicolo!

In caso di uso improprio o di modifiche del kit elettrico e delle componenti del medesimo, ogni diritto di garanzia decade. Durante la guida senza rimorchio o portacarichi, togliere sempre gli adattatori dalla presa di corrente. Con riserva di modifiche relative a costruzione, equipaggiamento, colore e salvo errori. Tutte le indicazioni e illustrazioni non sono vincolanti.

In caso di rimorchi non corredati di luce retronebbia, questa dovrebbe essere installata.

Per le modifiche tecniche ed elettroniche eseguite dopo la primissima in funzione del kit elettrico da parte del costruttore del veicolo, e che portano, per esempio, a un malfunzionamento della presa del rimorchio o della sua periferia, non ci assumiamo alcuna responsabilità!

Il modulo del rimorchio non è idoneo alla diagnosi! Nel caso in cui processi diagnostici o apparecchiature di prova controllate da software dovessero generare dei protocolli d'errore in rapporto diretto o indiretto con l'uso del rimorchio, si deve staccare il modulo del rimorchio dal conduttore per la presa del rimorchio, e avviare nuovamente la diagnosi!

(E)!

La instalación del conjunto eléctrico debe realizarse por un taller especial o una persona instruida. Antes de empezar cualquier trabajo de montaje es necesario leer el manual de montaje. Después de instalar el grupo eléctrico en los documentos de servicio del coche hay que incluir el manual de montaje.

En caso de incorrecto uso o introducción de cambios en el juego E o bien en caso de reemplazo de los subgrupos que se encuentran en el dispositivo, extingue la garantía. En caso de la ida sin remolque u otro dispositivo portador los conectores usador deben desconectarse de la caja de red. Nos reservamos el derecho de introducir cambios de construcción, cambios de equipo y de color así como el derecho de aparición de información errónea en los manuales de servicio. Toda la información, datos y figuras no son valederos.

En caso de los semiremolques sin faros antiniebla, hay que completar la iluminación.

¡No aceptamos ninguna responsabilidad a título de introducir cambios técnicos o electrónicos introducidos por el fabricante desde la puesta en marcha del juego eléctrico y cuyo objetivo, por ejemplo, sería incorrecto funcionamiento de la caja del remolque o sus dispositivos periféricos!

¡El módulo de remolque no está ajustado a realizar diagnósticos! En caso cuando los procesos diagnósticos que se realizan por el fabricante o los mecanismos de control asistidos por el software conducen a generar incorrectos protocolos que tienen relación directa o indirecta con el modo de remolque, es necesario desconectar el módulo de remolque del juego de conductos de la caja del remolque. ¡Luego, volver a realizar el procedimiento diagnóstico!

(CZ)!

Instalace elektrické jednotky musí být vykonaná specializickým servisem nebo kvalifikovanou osobou. Před zahájením všech montážních prací je třeba pečlivě přečíst celou montážní instrukci. Po zakončení instalace elektrické jednotky k servisním dokladům auta je třeba připojit montážní instrukci.

V případě nesprávné exploataci nebo zavádění neoprávněných změn v elektrické jednotce, případně výměny montážních podskupin nejsou poskytovány žádné záruky a uživatel nemá žádné nároky na záruční opravy. V případě jízdy bez přívěsu nebo jiného nosného zařízení používané spojky je třeba odpojit od síťové zásuvky. Vyhrazujeme si právo na zavádění konstrukčních změn a změn vybavení a barvy a připouštíme možnost chybných informací v návodech k obsluze. Veškeré informace, údaje a ilustrace nejsou závazné.

V případě přívěsu bez mlhových světel je třeba toto osvětlení doplnit.

Ne přejímáme žádnou odpovědnost z titulu zavádění technických nebo elektronických změn, které zavedl výrobce motorového vozidla od chvíle zprovoznění elektrické jednotky a které vedou k vadné funkci zásuvky přívěsu nebo dalších periferních zařízení!

Modul přívěsu není přizpůsobený k vykonávání diagnózy! V případě, že diagnostické procesy vykonávané výrobcem nebo kontrolní mechanizmy posilované softwarem budou mít za následek generování protokolů chyb, které mají přímou nebo nepřímou souvislost s režimem přívěsu, v kompletu elektrického vedení zásuvky přívěsu je třeba odpojit modul přívěsu. Potom je třeba opětovně zahájit diagnostickou proceduru!

(H)!

Az elektromos készlet beszerelését szakszervizre, vagy megfelelően képzett személyre kell bízni. A szerelési munkák megkezdése előtt feltétlenül el kell olvasni a teljes szerelési utasítást. Az elektromos készlet beszerelése után a szerelési utasítást hozzá kell csatolni a gépjármű szervizdokumentációjához.

A rendeltetésszerű használat, vagy változtatások bevezetése az E készleten belül, vagy a berendezés alegységeinek cseréje esetén a garanciális jogok hatályukat veszítik. Utánfutó vagy más szállítóeszköz nélküli közlekedés esetében az alkalmazott csatlakozókat le kell oldani a hálózati csatlakozójzatokról. Fenntartjuk a jogot a szerkezeti változtatásokhoz, a felszereltség és a szín megváltoztatásához, úgyszintén fenntartjuk a jogot a használati utasításokban téves információ megjelenéséhez. Az információk, adatok, illusztrációk nem jelentenek kötelezettségvállalást.

A kódlámpa nélküli utánfutók esetében ezt a világítást ki kell egészíteni.

Nem vállalunk semmilyen felelősséget a műszaki vagy elektronikai változtatások bevezetéséért, amelyeket a gépjármű gyártója vezetett be az elektromos készlet első üzembe helyezése pillanatától, és amelyek pl. az utánfutó csatlakozójzatának, vagy perifériás berendezéseinek hibás működéséhez vezetnek. Az utánfutó modul nem alkalmas diagnosztikai feladatokra.

Abban az esetben, ha a gyártó, vagy a szoftver által támogatott ellenőrzőrendszerek által végrehajtott diagnosztikai műveletek az utánfutó üzemmóddal közvetlenül vagy közvetetten összefüggő hibajelentések keletkezéséhez vezetnek, az utánfutó csatlakozójzat vezetékkötegéből ki kell kötni az utánfutó modult. Ezután a diagnosztikai eljárást meg kell ismételni!

(RU)!

Установка электрического комплекта должна быть выполнена в специализированной мастерской или соответственно обученным специалистом. Перед началом всех монтажных работ следует прочитать всю инструкцию по монтажу. После установки электрического комплекта к сервисным документам на машину надо приложить монтажную инструкцию.

Неправильное использование или введение изменений в области комплекта E, или изменение находящихся в устройстве узлов приводит к утрате гарантии. При езде без прицепа или другого несущего устройства используемые соединители надо отключать от розеток. Мы оставляем за собой право введения изменений в конструкции, оснастке и цвете, а также право появления ошибочной информации в инструкции по обслуживанию. Вся информация, данные и иллюстрации не имеют обязывающей силы.

Если прицеп не оснащён противотуманными фарами, такую оснастку надо установить.

Мы не берем на себя ответственности за введение технических или электронных изменений, которые ввел изготовитель транспортного средства от момента первого запуска электрического комплекта и которые ведут, например, к неправильному функционированию розетки прицепа или её периферийных устройств!

Модуль прицепа не приспособлен к проведению диагностики! Если диагностические процедуры проводились изготовителем или контрольные механизмы, поддерживаемые программным обеспечением, ведут к генерированию протокола ошибок, прямо или косвенно связанных с режимом прицепа, из комплекта проводов розетки прицепа надо отключить модуль прицепа. Затем повторно провести диагностическую процедуру!

(LT)!

Įmontuoti elektros prietaisų rinkinį rekomenduojama specialiose dirbtuvėse arba tai gali atlikti kvalifikuotas asmuo. Būtinai perskaitykite visą įmontavimo instrukciją ir tik tada pradėkite montavimo darbus. Baigus elektros prietaisų rinkinio montavimo darbus, prieš transporto priemonės techninės priežiūros dokumentų padėkite įmontavimo instrukciją.

Neteisingas reikalauti garantinio aptarnavimo, jei naudosite ne pagal paskirtį arba pertvarkysite elektros prietaisų rinkinį ir jame esančius konstrukcinius elementus. Važiuojant be priekabos arba krovininio transporterio, iš elektros lizdo būtina ištraukti adapterius, jei tokie naudojami. Pasielkime teisę keisti konstrukciją, įrangą, spalvas ir neprisiimame atsakomybės dėl klaidų. Visi duomenys ir paveikslėliai gali būti netikslūs.

Jei ant priekabos nėra galinių priešrūkinių žibintų, juos būtina įmontuoti.

Mes neprisiimame jokios atsakomybės už techninius arba elektroninius pakeitimus, kurie atliekami po pirmojo elektros prietaisų rinkinio įjungimo, atliekamo transportopriemonės gamintojo, ir netinkamą, pavyzdžiui, priekabos elektros lizdo arba periferinių prietaisų veikimą!

Priekabos modulio diagnostikos atlikti negalima! Jei gamintojai atliekant diagnostikos procesus arba tikrinimo mechanizmai su programine įranga kuria gedimų protokolus, kurie tiesiogiai arba netiesiogiai yra susiję su priekabos režimu, nuo priekabos modulio būtina atjungti laidus, vedančius į priekabos elektros lizdą, ir iš naujo įjungti diagnostikos procesą!

(LV)!

Elektroierīces iemontēšanu jāveic specializētā darbnīcā vai attiecīgu kvalifikāciju ieguvušām personām. Pirms montāžas darbu sākšanas noteikti pilnībā izlasiet montāžas pamācību. Pēc elektroierīces iemontēšanas servisa dokumentu montāžas pamācība jāieliek transportlīdzeklī. Nepareizas elektroierīces vai tās konstrukcijas daļu lietošanas vai pārbūves gadījumā zūd jebkādas garantijas saistības.

Braucot bez piekabes vai kravu pārvadāšanas mehānisma nepieciešamības gadījumā izmantotie adapteri vienmēr jāizņem no kontaktlīdzdas. Paturam tiesības veikt konstrukcijas, aprīkojuma, krāsas izmaiņas izņemot kļūdas. Visi dati un attēli nav saistoši.

Piekabēm bez aizmugurējiem miglas lukšuriem jāveic papildu aprīkošana.

Par tehniska rakstura vai elektronikas izmaiņām, kas tiek veiktas pēc elektroiekārtas pirmās ekspluatācijas sākšanas un kuras veic transportlīdzekļa ražotājs un ja tās, piemēram, rada kļūdainu piekabes kontaktlīdzdas vai tās perifērijas darbību, mēs neuzņemamies nekādas garantijas saistības!

Piekabes modulis nevar veikt diagnostiku! Ja ražotāja diagnostikas procesi vai programmatūras atbalstīti pārbaudes mehānismi sniedz kļūdainus ierakstu protokolus, kas tieši vai netieši ir saistīti ar braukšanu sakabes režīmā, tad piekabes modulis jāatdala no piekabes kontaktlīdzdas un vēlreiz jāsāk diagnostikas process!

(EST)!

Elektroonikakomplekti peab paigaldama eritöökoda või vastavate kvalifikatsioonidega isik. Lugege enne kõikiide monteerimistööde algust paigaldusjuhend täielikult läbi. Pange pärast elektroonikakomplekti paigaldamist paigaldusjuhend sõiduki teenindusdokumentatsiooni juurde.

Elektroonikakomplekti või selles sisalduvate detailide oskamatu kasutamise või muutmise puhul kaob igasugune õigus garantiinõuete esitamisele. Järeelhaagise või koormakandurita sõitmisel tuleb vastavad adapterid alati pistikupesast eemaldada. Jätame endale õiguse muudatusteks konstruksiooni, varustuse värvil ning eksituste suhtes.

Andmed ja joonised pole õiguslikult siduvad.

Kui järeelhaagisel puuduvad tagumised udutuled, siis tuleb need paigaldada. Meie garantii ei laiene tehnilistele/elektroonilistele muudatustele, mida teeb sõidukitootja pärast elektroonikakomplekti esmakordset kasutuselevõtmist ja mis põhjustavad näiteks järeelhaagise pistikupesa või perifeeriaseadmete tõrkeid!

Järeelhaagise moodul pole diagnostikavõimeline! Kui tootjapoolsed diagnostikaprotsessid või tarkvaratoega kontrollmehhanismid genereerivad valeprotokolle, mis on otseselt või kaudselt seotud järeelhaagise režiimiga, tuleb järeelhaagise moodul järeelhaagise pistiku kaablikomplektist lahutada ja diagnostikaprotseduur taaskäivitada!

(SK)!

Elektrický systém musí inštalovať špecializovaná dielňa alebo kvalifikovaná osoba. Pred začatím všetkých montážnych prác si prečítajte celý návod na montáž. Po inštalovaní elektrického systému pripojte k servisným dokladom automobilu návod na montáž.

Nesprávne používanie alebo vykonávanie zmien v rozsahu kompletu E alebo výmena konštrukčných častí v zariadení vedie k strate nároku na záruku. V prípade jazdy bez prívessu alebo iného nosného zariadenia používané spojky odpojte zo sieťových zásuviek. Vyhradzujeme si právo na vykonávanie konštrukčných zmien, zmien vybavenia a farby ako aj právo na chybné informácie zistené v návode na obsluhu. Žiadne informácie, údaje a ilustrácie nemajú záväznú moc.

V prípade prívessov bez hmlových svetiel je toto osvetlenie potrebné doplniť.

Nepreberáme žiadnu zodpovednosť za zavedenie technických alebo elektronických zmien, ktoré zaviedol výrobca automobilu od chvíle prvého spustenia elektrického systému a ktoré vedú napríklad k nesprávnemu fungovaniu zásuvky prívessu alebo jeho periférnych zariadení!

Modul prívessu nie je prispôbený vykonávaniu diagnózy! V prípade, ak diagnostické procesy vykonávané výrobcem alebo kontrolné mechanizmy podporované softvérom vedú ku generovaniu chybových protokolov priamo alebo nepriamo súvisiacich s voľbou prívessu, z kompletu vodičov zásuvky prívessu je potrebné odpojiť modul prívessu. Následne znovu vykonajte diagnostickú procedúru!

(PL)!

Instalacja zestawu elektrycznego powinna być przeprowadzona przez warsztat specjalistyczny lub odpowiednio wykwalifikowaną osobę. Przed rozpoczęciem wszelkich prac montażowych koniecznie przeczytać należy całą instrukcję montażu. Po instalacji zestawu elektrycznego do dokumentów serwisowych pojazdu samochodowego dołączyć należy instrukcję montażu.

W przypadku nieprawidłowego używania lub wprowadzenia zmian w obrębie kompletu E, albo w przypadku wymiany znajdujących się w urządzeniu podzespołów, wygasają roszczenia gwarancyjne. W przypadku jazdy bez przyczepy lub innego urządzenia nośnego używane łączniki należy odłączać od gniazd sieciowych. Zastrzegamy sobie prawo do wprowadzania zmian konstrukcyjnych, zmian wyposażenia i koloru, a także prawo do pojawiania się błędnych informacji w instrukcjach obsługi. Wszystkie informacje, dane i ilustracje nie posiadają mocy wiążącej.

W przypadku przyczep bez świateł przeciwmgielnych, oświetlenie to należy uzupełniać.

Nie przejmujemy żadnej odpowiedzialności z tytułu wprowadzania technicznych lub elektronicznych zmian, które wprowadził producent pojazdu samochodowego od chwili pierwszego uruchomienia zestawu elektrycznego i które prowadzą na przykład do błędnego funkcjonowania gniazda przyczepy lub jego urządzeń peryferyjnych!

Moduł przyczepy nie jest przystosowany do przeprowadzania diagnozy! W przypadku, gdy procesy diagnostyczne przeprowadzane przez producenta lub mechanizmy kontrolne wspomagane przez oprogramowanie doprowadzają do generowania protokołów błędów posiadających związek pośredni lub bezpośredni z trybem przyczepy, z kompletu przewodów gniazda przyczepy odłączyć należy moduł przyczepy. Następnie powtórnie przeprowadzić należy procedurę diagnostyczną!

7-pin

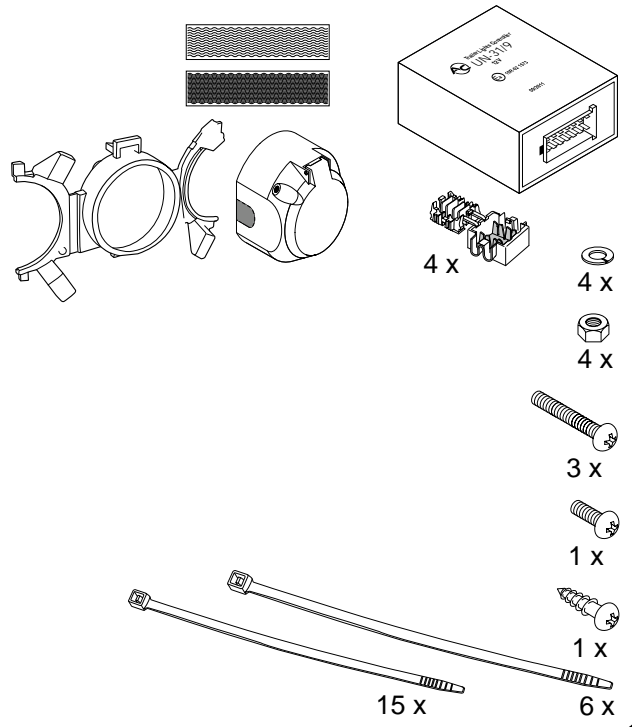
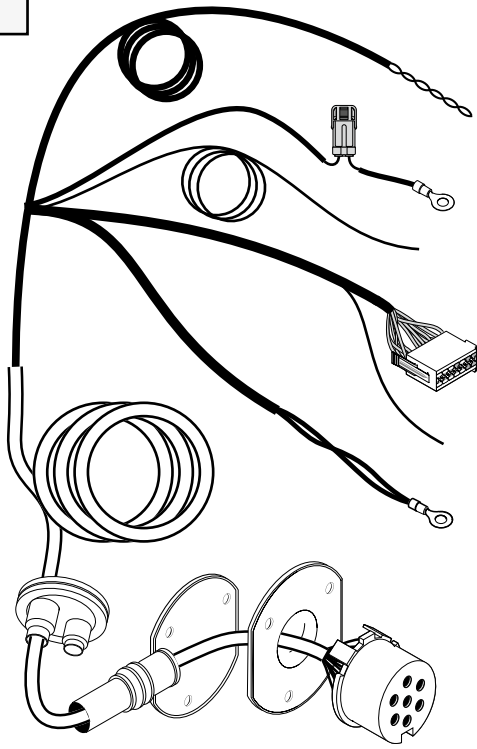

13-pin

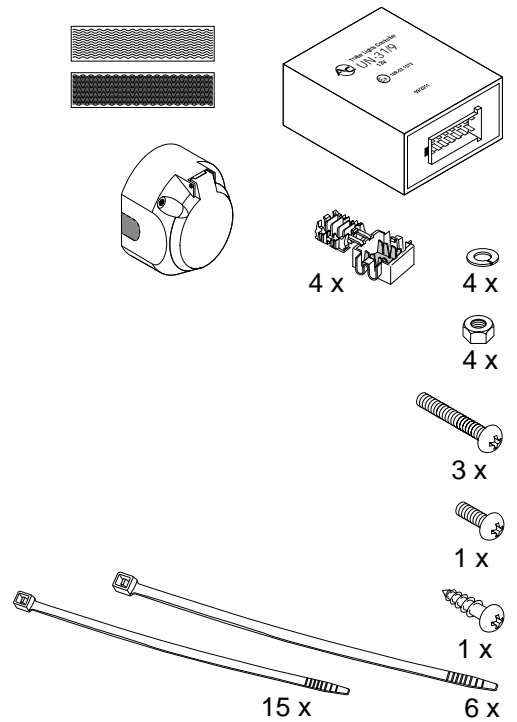
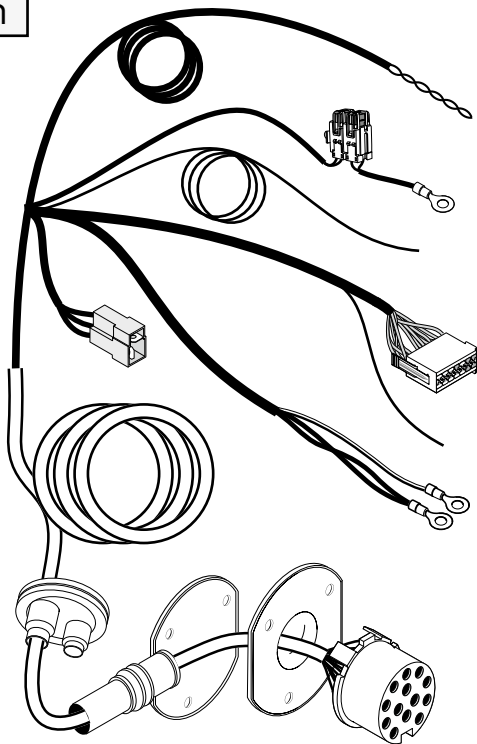

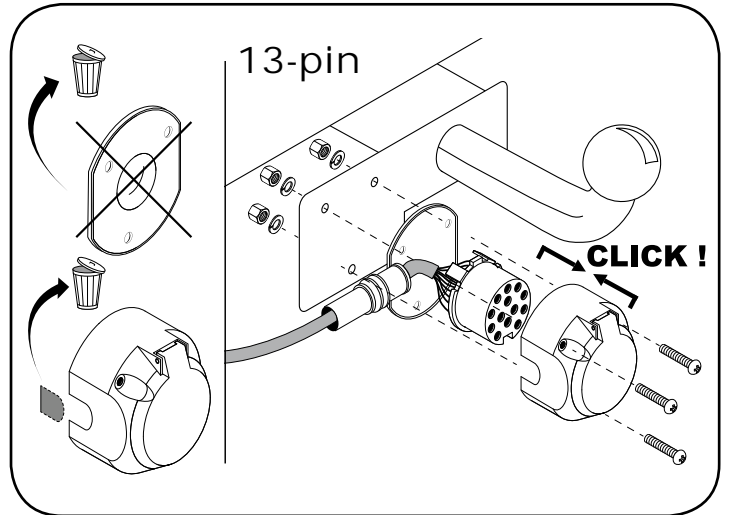
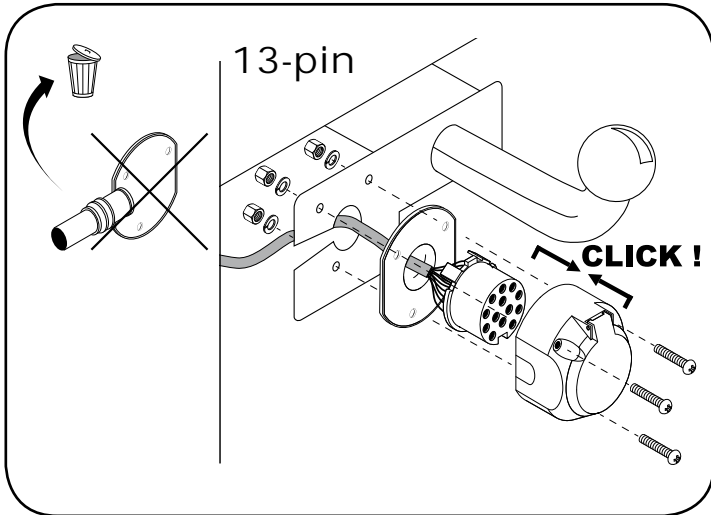
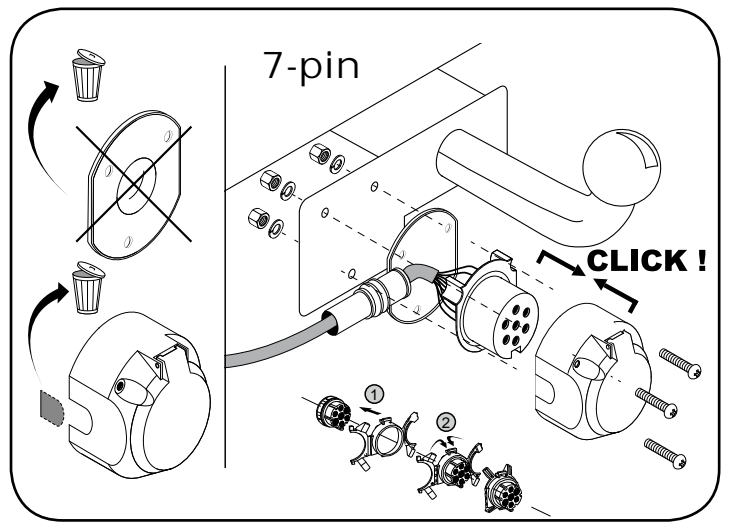
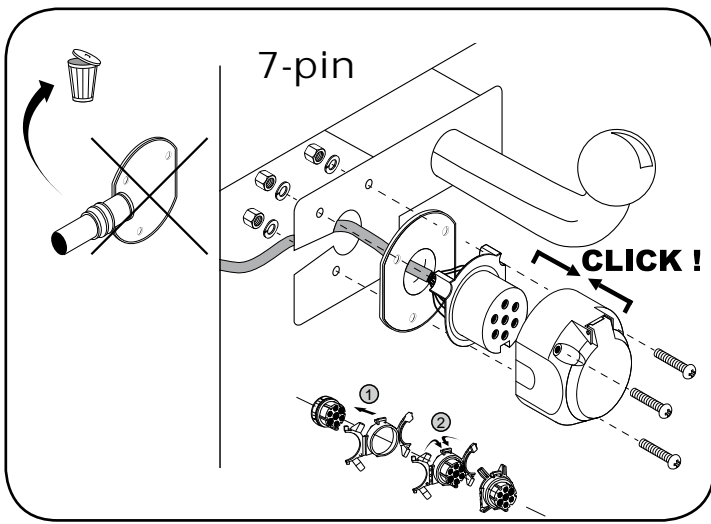

7-pin + 13-pin		
1	bk / wh	←
2	gy	
3	bn	
4	bk / gn	→
5	gy / rd	
6	bk / rd	
7	gy / bk	
13-pin		
8	bu / rd	
9	rd / bu	
10	ye	
11	wh / bn	
12	no	
13	wh / bn	

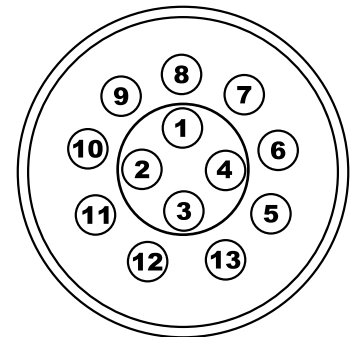
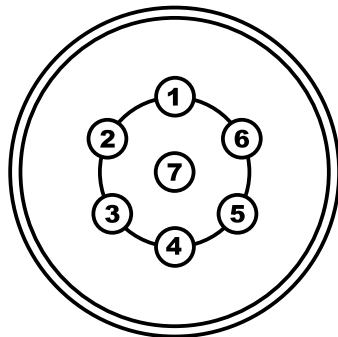

	wh	bk	ye	bn	gy	gn	rd	bu	or	pu	no
(D)	weiss	schwarz	gelb	braun	grau	grün	rot	blau	orange	violett	nicht belegt
(GB)	white	black	yellow	brown	grey	green	red	blue	orange	purple	not occupied
(F)	blanc	noir	jaune	brun	gris	vert	rouge	bleu	orange	violet	inutilisé
(NL)	wit	zwart	geel	bruin	grijs	groen	rood	blauw	oranje	violet	niet aangesloten
(DK)	hvid	sort	gul	brun	grå	grøn	rød	blå	orange	violet	ikke anvendt
(N)	hvit	svart	gul	brun	grå	grøn	rød	blå	oransje	fiollett	ikke i bruk
(S)	hvit	svart	gul	brun	grå	grönn	röd	blå	orange	violett	ej använd
(FIN)	valkoinen	musta	keltainen	ruseka	harmaa	vihreä	punainen	sininen	oranssi	violetti	ei varattu
(I)	bianco	nero	giallo	marrone	grigio	verde	rosso	blu	arancione	viola	libero
(E)	blanco	negro	amarillo	marón	gris	verde	rojo	azul	anaranjado	violetta	no ocupado
(CZ)	bílý	černý	žlutý	hnědý	šedý	zelený	červený	modrý	oranžový	vialový	neobsazen
(H)	fehér	fekete	sárga	barna	szürke	zöld	piros	kék	narancssárga	lbolyakék	nem foglalt
(RU)	белый	черный	жёлтый	коричневый	серый	зеленый	красный	голубой	пурпурный	оранжевый	свободно
(LT)	balta	juoda	geltona	ruda	pilka	žalia	raudona	mėlyna	oranžinė	purpurinė	laisva
(LV)	balta	meina	dzeltena	bruna	peleka	zala	sarkana	zila	oranža	purpursarkana	brvrs
(EST)	valge	must	kollane	pruun	hall	roheline	punane	sinine	oraanž	purpurpunane	vaba
(SK)	bela	čierny	žltý	hnedý	šedý	zelený	červený	modrý	pomarančový	fialový	neosadený
(PL)	biały	czarny	żółty	brązowy	szary	zielony	czerwony	niebieski	pomarańczowy	fioletowy	wolny

Anhängerbetrieb konfigurieren / Set up trailer operation

(D)!

Achtung!!!

Ein Defekt der Blinker des Anhängers wird im Anhängerbetrieb von der fahrzeugseitigen Kontrollleuchte über eine Erhöhung der Blinkfrequenz angezeigt!!

Alle Leitungsstränge mit beiliegenden Kabelbindern befestigen, alle Verkleidungen und demontierten Teile wieder einbauen.

Der Elektrosatz ist nicht diagnosefähig und das Bordnetzsteuergerät wird nicht codiert.

Die Batterie wieder anschließen und sämtliche Fahrzeugfunktionen mit angeschlossenem Anhänger oder einem geeigneten Prüfgerät überprüfen.

Die Einbauanleitung ist dem Kunden auszuhändigen!!!

(GB)!

Warning!!!

Trailer indicator defect is signalled by a control light of the vehicle by increased flashing frequency!!

Fix all the leads with supplied band clips, assemble previously disassembled parts.

The electric set is not trouble-shootable and the deck network control is not coded.

Connect accumulator and check all vehicle functions with connected trailer or other suitable testing device.

Assembly instruction for the customer.

(F)!

Attention!

Un défaut du clignotant est signalé par un indicateur de contrôle du véhicule qui clignote plus vite !!!

Fixer tous les câbles à l'aide de bornes à bande, monter les pièces précédemment démontées.

L'ensemble électrique n'est pas diagnosable et le pilote du réseau de bord n'est pas codé.

Brancher l'accumulateur et vérifier toutes les fonctions du véhicule avec la remorque raccordée ou par l'intermédiaire d'un instrument de test.

Instructions de montage sont destinées au client.

(NL)!

Let op!

De beschadiging van een knipperlicht van de aanhangwagen wordt door een hogere frequentie van het knipperen van controlelampje in het voertuig aangegeven.

Alle leidingen monteren met behulp van de bijgevoegde klembanden, eerder gedemonteerde onderdelen weer aanbrengen.

De elektrische set kan niet gediagnosticeerd worden en het besturingsmechanisme van het boordnetwerk is niet gecodeerd.

De accu aansluiten en alle functies van het voertuig met aangekoppelde aanhanger of geschikt testapparaat controleren.

Montage-instructie is voor de klant bestemd.

(DK)!

Bemærk!!!

Fejl i påhængskøretøjets blinklys meldes af konstant blink af køretøjets kontrollys!!

Alle ledninger fastgøres med de medleverede båndklemmer, de tidligere afmonterede dele monteres på igen.

Elektrosættet kan ikke diagnosticeres og styringen bliver ikke kodet.

Bilbatteriet tilsluttes og dernæst skal man checke samtlige funktioner af køretøjet med sammenkoblet påhængskøretøj, event. ved brug af et passende prøveudstyr.

Montagevejledningen er for kunden.

(N)!

Forsiktig!!!

Defekt av tilhengerens blinklys signaliseres med bilens kontrollys ved å øke blinkefrekvensen!!

Alle ledningene monteres ved hjelp av vedlagte strekkavlastere, monter så alle demonterte elementer tilbake på plass.

Elektrosættet kan ikke diagnostiseres og er ikke kodet for kjøretøyet datamaskin.

Tilkoble batteriet og test kjøretøyet funksjoner med tilhenger eller bruk et egnet testapparat.

Monteringsanvisning for kunden.

(S)!

Varning!!!

Släpvgandefekt signaliseras av kontrolljus genom en högre blinkfrekvens.

Sätta fast alla ledningar med bifogade bandklämmor, montera tidigare demonterade delar.

Elsatsen kan inte diagnostiseras och elsystemet kodas inte.

Förbinda en ackumulator och testa alla fordonets funktioner med en förbunden släpvgagn eller en lämplig testanordning.

Monteringsanvisning för kunden.

(FIN)!

Huomio!!!

Perävaunun vilkun vika osoitetaan ajoneuvon kontrollivalon vilkuntataajuuden nostamisella!!

Kytke kaikki johdot liitettyjen nippusiteiden avulla. Asenna aikaisemmin irrotetut osat.

Sähkösarja ei kykene virheenmäärittelyyn eikä ajoneuvon verkkojousilaitetta koodata.

Kytke akku ja tarkista sopivalla testauslaitteella, toimivatko kaikki ajoneuvon ja kytketyt perävaunun toiminnot.

Asiakkaalle tarkoitettujen kokoonpanon ohjeet.

(I)!

Attenzione!!!

Un difetto del lampeggiatore del rimorchio è segnalato da una lampada di controllo del veicolo che comincia a lampeggiare più velocemente!

Fissare tutti i cavi a mezzo dei orsetti a nastro in dotazione, fissare i pezzi precedentemente smontati.

Il kit elettrico non è diagnosticabile e il combinatore della rete di bordo non è codificato.

Collegare l'accumulatore e verificare tutte le funzioni del veicolo con il rimorchio collegato o a mezzo di uno strumento di test.

Le istruzioni per il montaggio sono destinate al cliente.

(E)!

¡NOTA!

Una avería del intermitente de remolque se señaliza con el parpadeo de la luz de control de vehículo de la frecuencia aumentada.

Fijar todos los conductores con bornes de cinta, remontar todas partes desmontadas anteriormente.

El conjunto eléctrico no es diagnosticable, el controlador de la red de abordo no está codificado.

Conectar el acumulador y verificar todas las funciones del vehículo con remolque o con un instrumento apropiado.

Instrucción de montaje está destinada para cliente.

(CZ)!

Pozor!!!

Chyba světelného ukazatele přívěsu je signalizována prostřednictvím světelné kontrolky vozidla tím, že tato bliká s vyšší frekvencí!!

Všechny vodiče upevnit pomocí přiložených pásových sponek, namontovat zpět dříve odmontované části.

Elektrická súpava nie je diagnostikovateľná a ovládač palubnej siete nie je kódovaný ovládač.

Připojit akumulátor a zkontrolovat všechny funkce vozidla s připojeným přívěsem nebo pomocí odpovídajícího testujícího zařízení.

Montážní instrukce je určena pouze pro zákazníka!!!

(H)!

Figyelem!!!

Az utánfutó index működési hibáját kijelzi a kocsí belsejében szerelt visszajelző, amikor gyorsabban villog!!

Minden vezetékét rögzíteni kell a mellékelt műanyag kábelkötegelőkkel, és ne feledje a kiszereelt alkatrészeket visszaszerelni!

Az elektromos készlet nem diagnosztizálható, a fedélzeti hálózat vezérlője nem kódolt.

Kösse vissza az akkumulátor kábelsaruját, és rákapcsolt utánfutónál, teszt műszer segítségével ellenőrizze a kocsí minden funkcióját, helyes működés szempontjából.

A szerelési útmutató az ügyfeleknek készült !!!

(RU)!

Внимание!!!

Дефект поворотника прицепа сигнализирует контрольная лампочка автомобиля, увеличивая частоту мигания!!

Все провода надо крепить приложенными ленточными зажимами, установить ранее разобранные детали.

Электрический комплект не диагностируется, а контроллер бортовой сети не кодируется.

Подключите аккумулятор и проверьте все функции автомобиля с присоединенным прицепом, или при помощи соответствующего тестера.

Монтажная инструкция предназначена для клиента.

(LT)!

Uzmanību!

Priekabos signālo defektas yra signalizuojamas transporto priemonės kontrolinė šviesla pagreitėjusiu signalizavimo greičiu!!

Visus laidus sumontuokite pridėjtais juostiniais gnybtais, sumontuoti anksčiau sumontuotas dalis.

Elektros įrenginio negalima patikrinti diagnostikos sistema ir transporto priemonės valdymo prietaisais neužkoduojamas.

Pajungkite akumuliatorių ir patikrinkite visas transporto priemonės funkcijas su prijungta priekaba arba atitinkamu testuojančiu prietaisu.

Montavimo instrukcija klientui!!!

(LV)!

Dēmesio!!!

Piekabes signāla defekta gadījumā mirgo transportlīdzekļa kontrollampiņa!!

Visu kabelu montāža jāveic, izmantojot pievienotās joslas spaiļes, kas savieno iepriekš samontētās daļas.

Elektriskā aprīkojuma komplektam nav paredzēta diagnostika, un borta elektroīkla vadības ierīce nav kodēta.

Pievienojiet akumulatoru un pārbaudiet visas transportlīdzekļa funkcijas ar piekabinātu piekabi vai izmantojot attiecīgu testēšanas ierīci.

Montāžas instrukcija klientam!!!

(EST)!

Tähelepanu!!!

Haagise suunatud rikked annab märku sõiduki signaallamp suurema vilkumissagedusega.

Elektrisüsteem ei ole diagnoosivõimeline ja pardavõrgu juhtimiseadet ei kodeerita.

Kõik juhtmed kinnitage kaasasolevate lintklambritega, eelnevalt monteeringe lahtivõetud osad.

Ühendage külge aku ja kontrollige kõiki sõiduki funktsioone ühendatud haagise või vastava kontrollimõõteriistaga.

Paigaldusjuhend on mõeldud kliendile!!!

(SK)!

Poznámka!!!

Poruchu smerovky prívěsu signalizuje kontrolné svetlo vozidla prostredníctvom zvýšenia frekvencie blikania!!

Všetky vodiče připevníte příloženými stahovacími páskami, namontujte skôr demontované diely.

Elektrická súpava nie je diagnostikovateľná a ovládač palubnej siete nie je kódovaný ovládač.

Připojte akumulátor a skontrolujte všetky funkcie vozidla s pripojeným prívěsom alebo s príslušným testovacím prístrojom.

Montážny návod je určený pre zákazníka !!!

(PL)!

Uwaga!!!

Defekt migacza przyczepty jest sygnalizowany przez światło kontrolne pojazdu poprzez podwyższenie częstotliwości migania!!

Wszystkie przewody zamocować dołączonymi zaciskami taśmowymi, zamontować wcześniej rozmontowane części.

Zestaw elektryczny nie jest diagnozowalny, a sterownik sieci pokładowej nie jest kodowany.

Podłączyć akumulator i sprawdzić wszystkie funkcje pojazdu z podłączoną przyczepą lub odpowiednim przyrządem testującym.

Instrukcja montażu przeznaczona jest dla klienta.

No. 043007-13

BMW F20 Bj. 03.14-

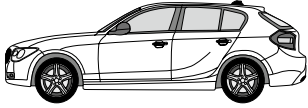

BMW F21 Bj. 03.14-

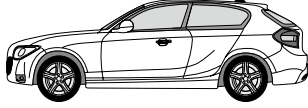

BMW F22 Bj. 03.14-



BMW F23 Bj. 03.15-

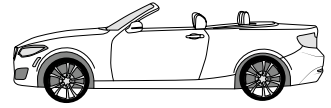

KIT 043007

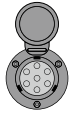

KIT 043013



- (D)** Elektrischer Anbausatz für Anhängerkupplung
- (GB)** Electrical Set for Trailer Connection
- (F)** Ensemble électrique pour brancher le crochet d'attelage
- (NL)** Elektrische aansluitset voor trekhaak
- (DK)** Elektrisk tilslutningssæt for trakkrog
- (N)** Elektrisk monteringssett for tilhengerkontakt
- (S)** Elektrisk förbindelsebyggsats av bogseringskrok
- (FIN)** Hinauskoukun sähköliitännäpaketti
- (I)** Kit di congiunzione del gancio per rimorchio
- (E)** Juego de conexión eléctrica de gancho de remolque
- (CZ)** Elektrická připojovací sestava tažného zařízení
- (H)** Elektromos kábelköteg vonóhorog bekötéséhez
- (RU)** Электрический присоединительный комплект буксирного крюка
- (LT)** Elektroninis jungiamasis traukimo kablio rinkinys
- (LV)** Elektroniskais vilkšanas āķa savienojuma komplekts
- (EST)** Elektriline tiisli ühenduskomplekt
- (SK)** Elektroinštalácia pre zapojenie ťažného zariadenia
- (PL)** Elektryczny zestaw przyłączeniowy haka holowniczego

7-pin

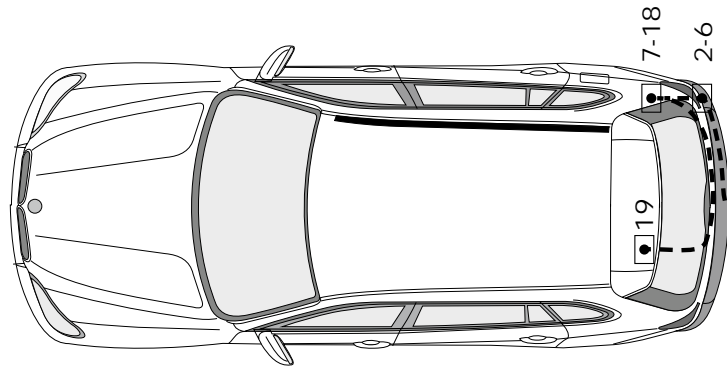
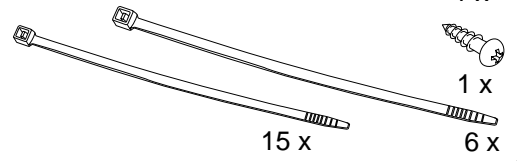
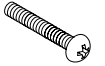
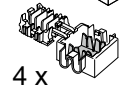
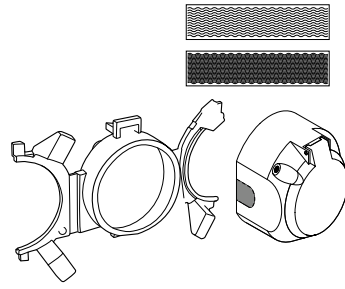
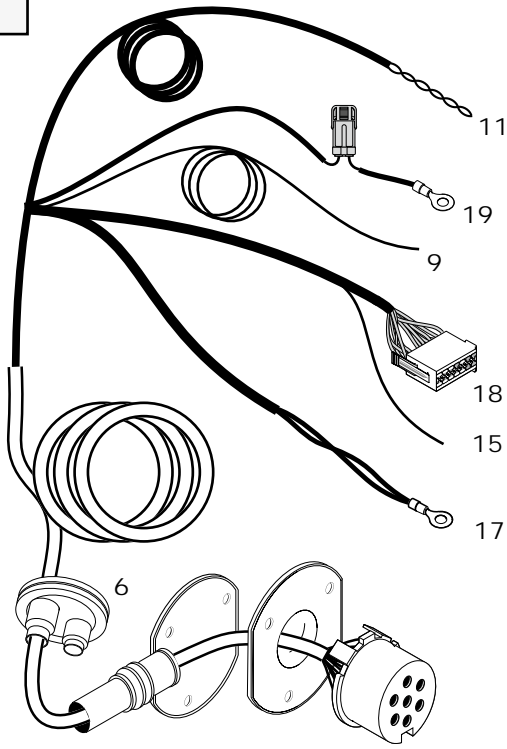

13-pin

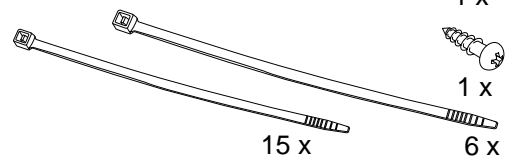
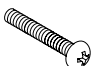
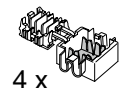
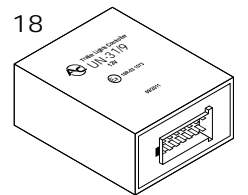
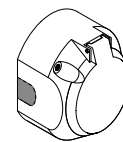
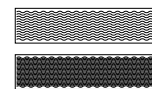
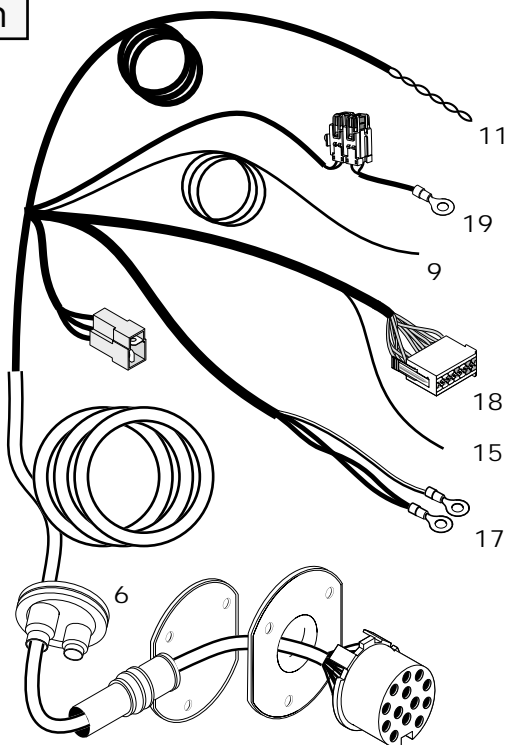

1

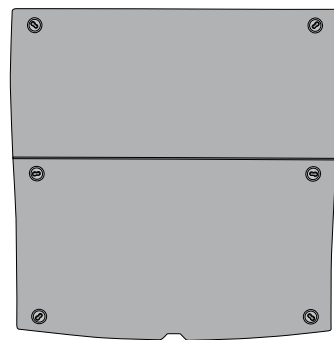
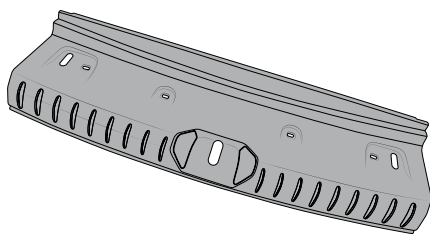
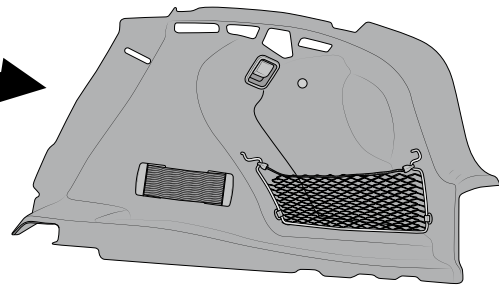
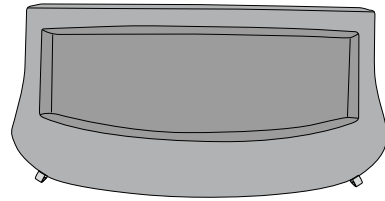
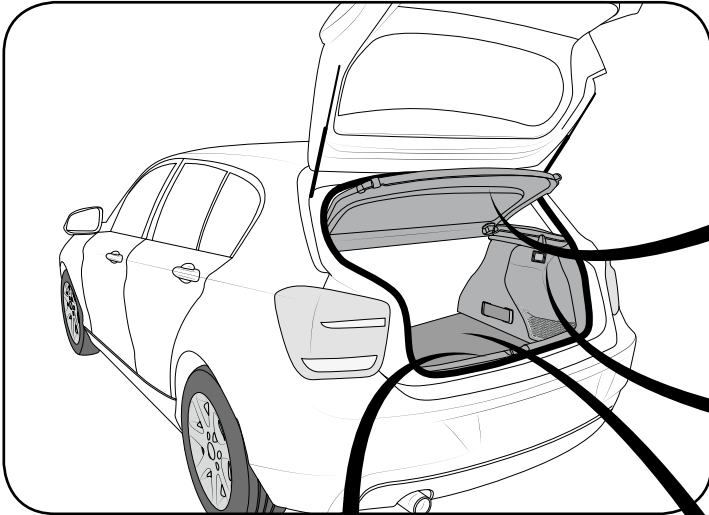
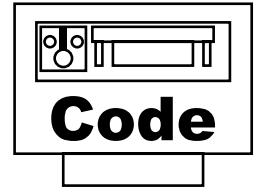
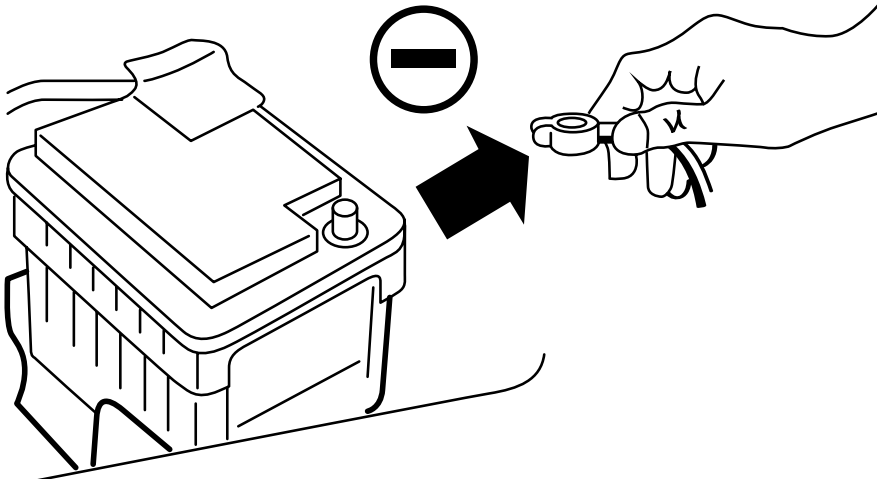

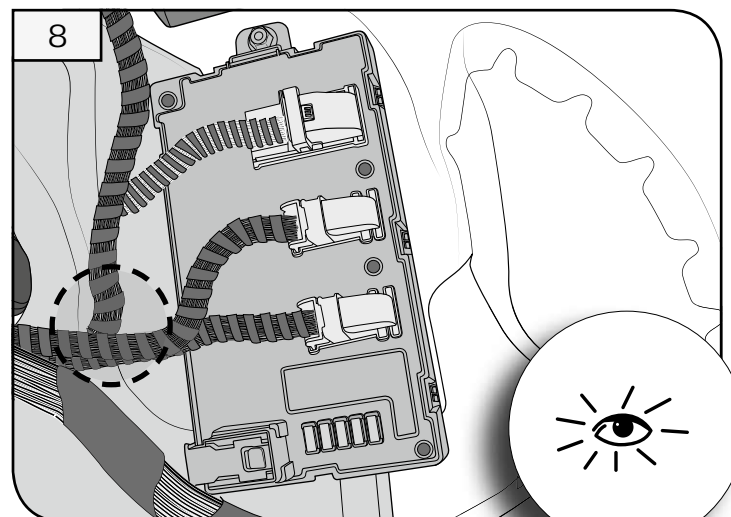
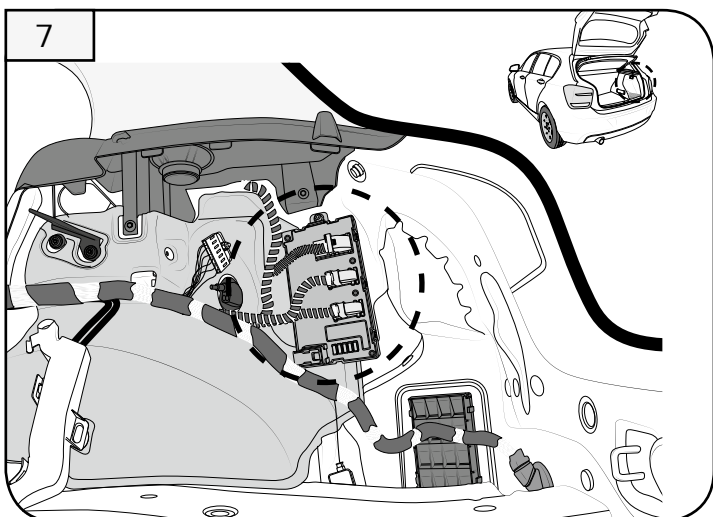
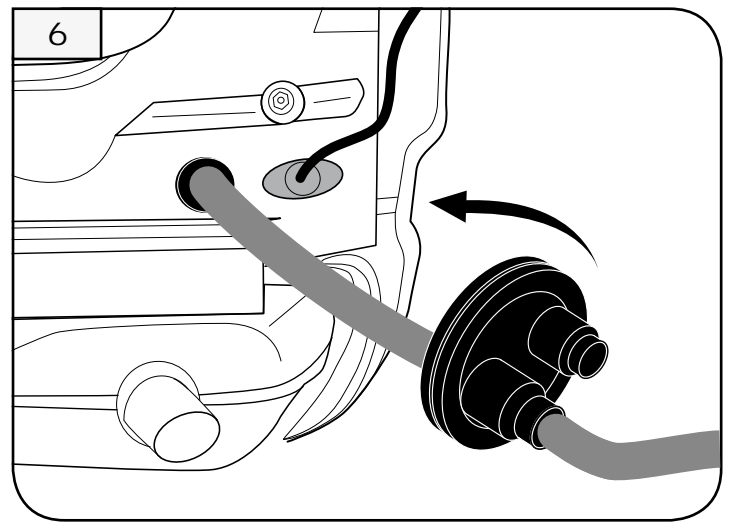
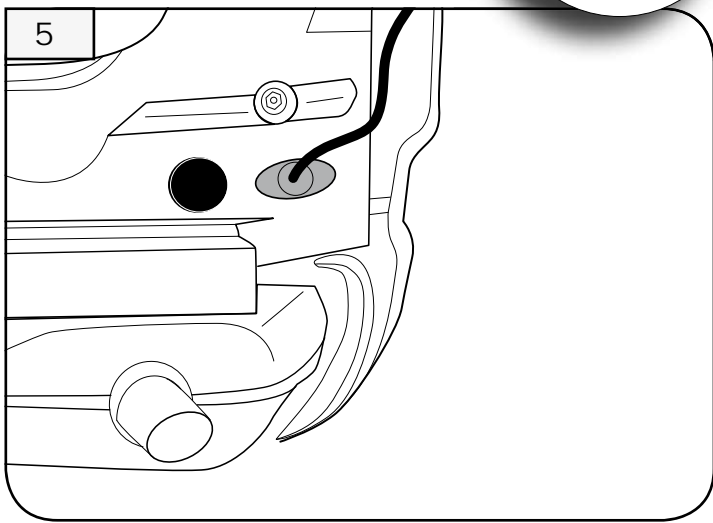
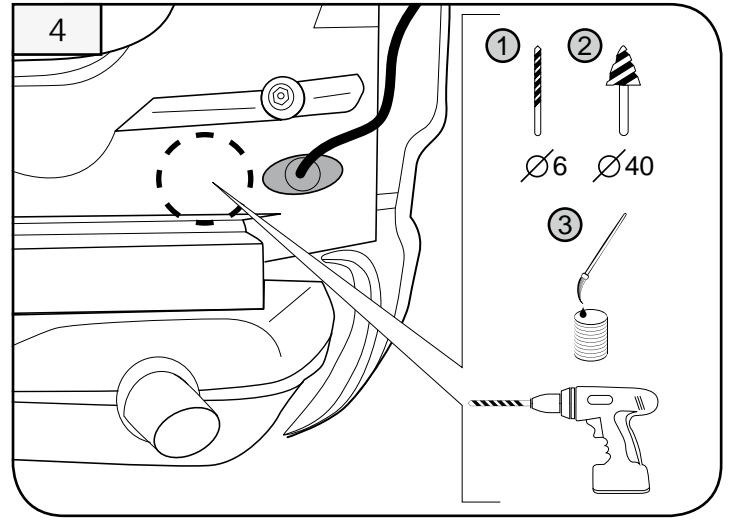
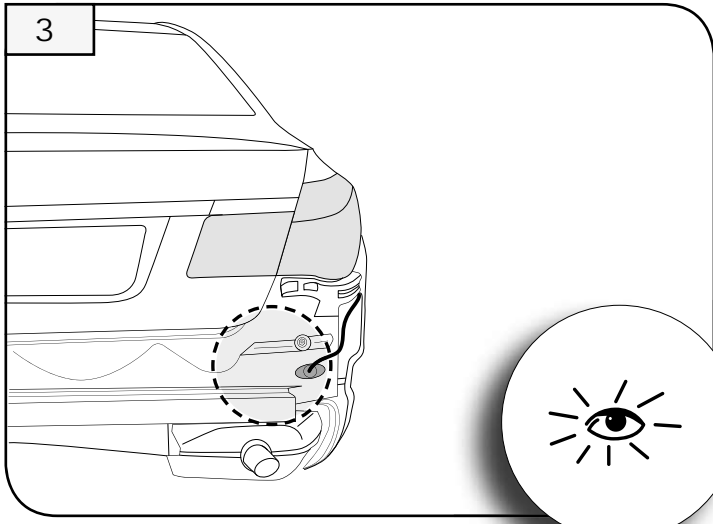
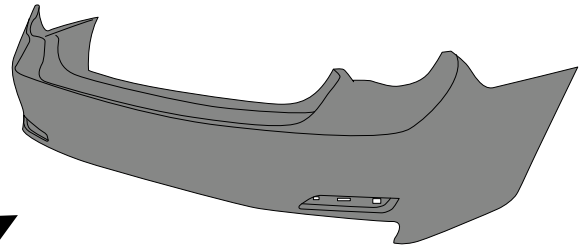
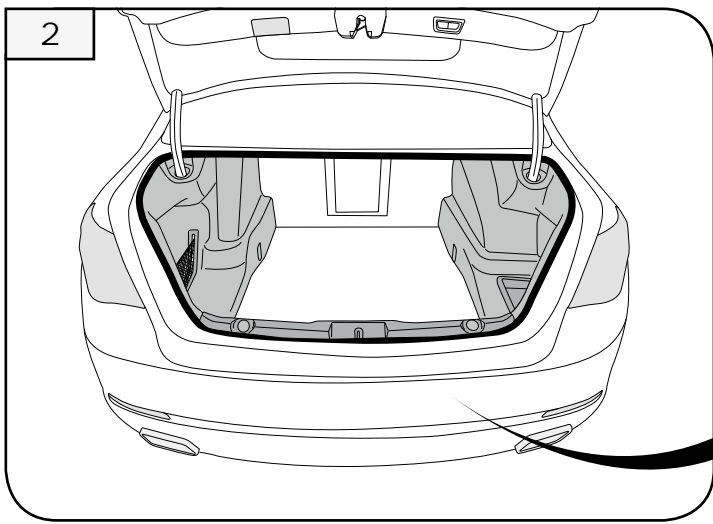

9



bk/ye
STOP

CAN

ye/rd
ye/bn

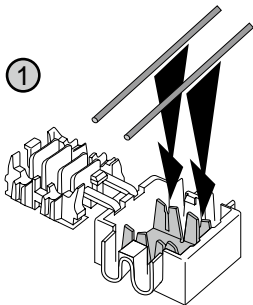
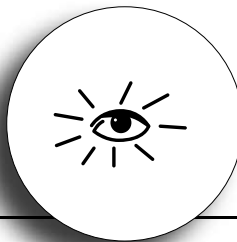

1

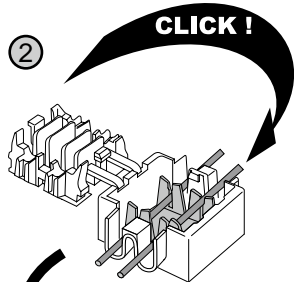

2

CLICK !

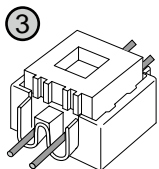

3

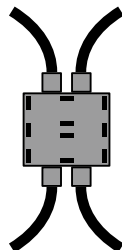

10

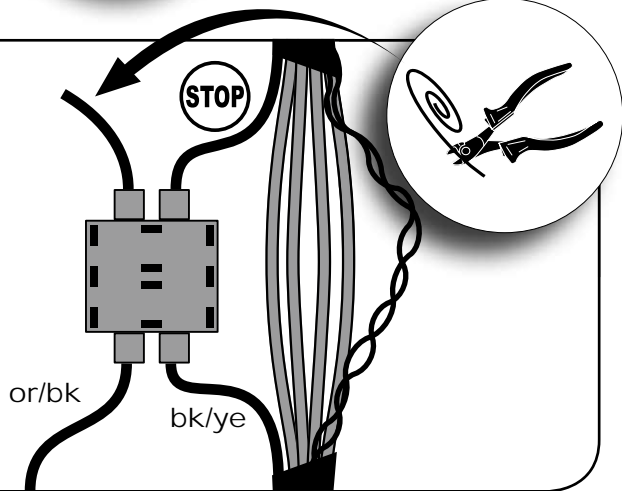

STOP

or/bk

bk/ye

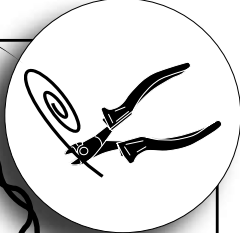

E-Satz or/bk → kabel bk/ye
e-kit or/bk → cabel car bk/ye

STOP

11

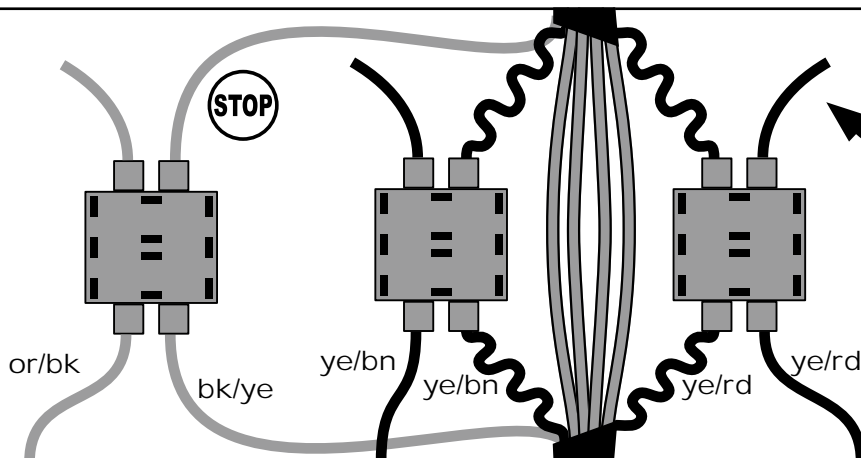

STOP

or/bk

bk/ye

ye/bn

ye/bn

ye/rd

ye/rd

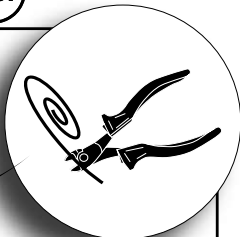

E-Satz ye/bn → kabel ye/bn, E-Satz ye/rd → kabel ye/rd
e-kit ye/bn → cabel car ye/bn, e-kit ye/rd → cabel car ye/rd

12

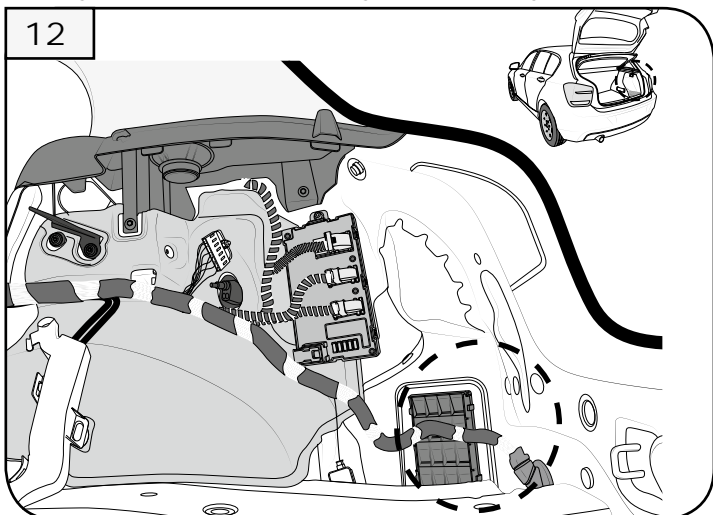

13

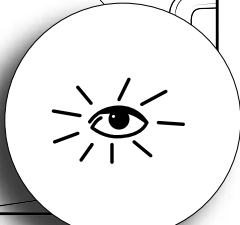
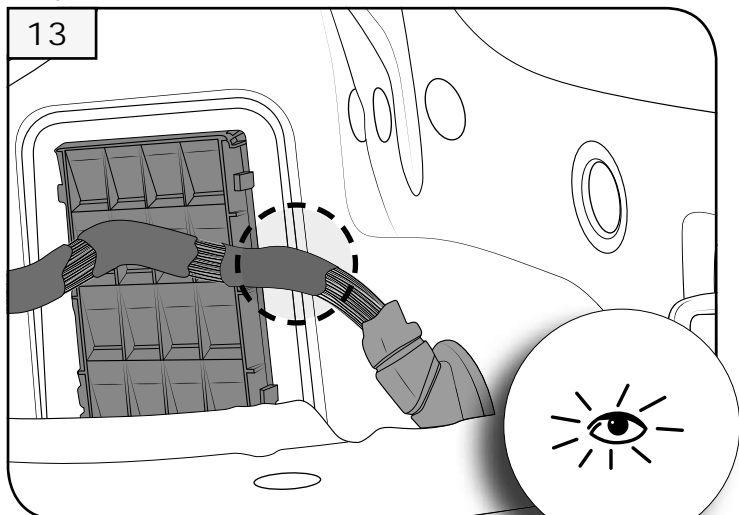

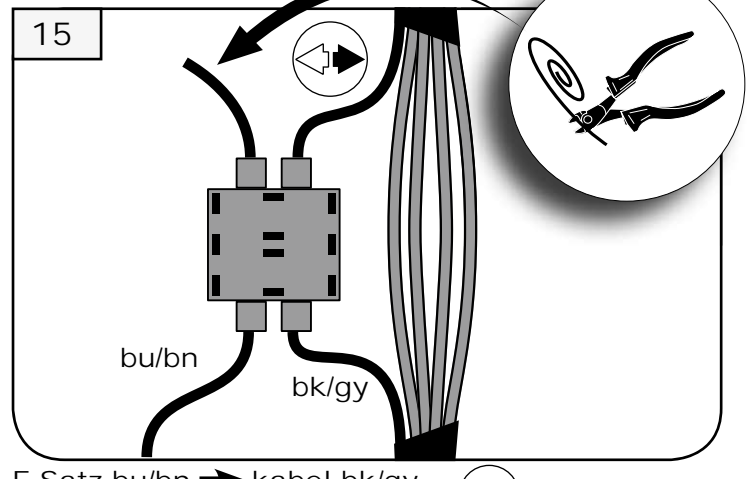
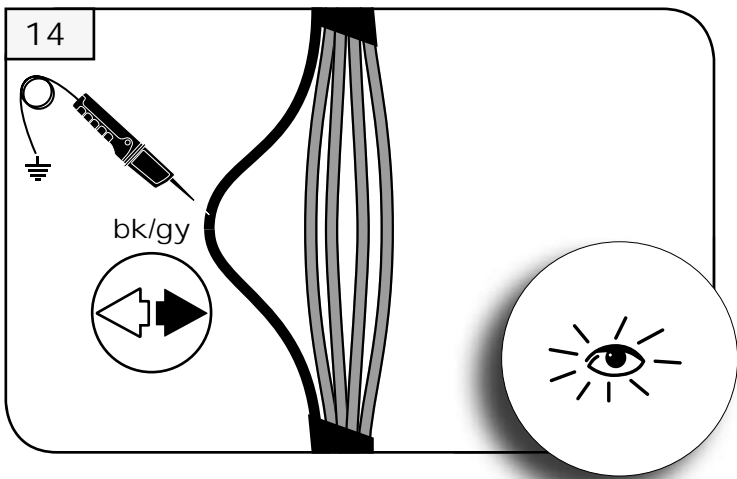

E-Satz bu/bn → kabel bk/gy
 e-kit bu/bn → cabel car bk/gy

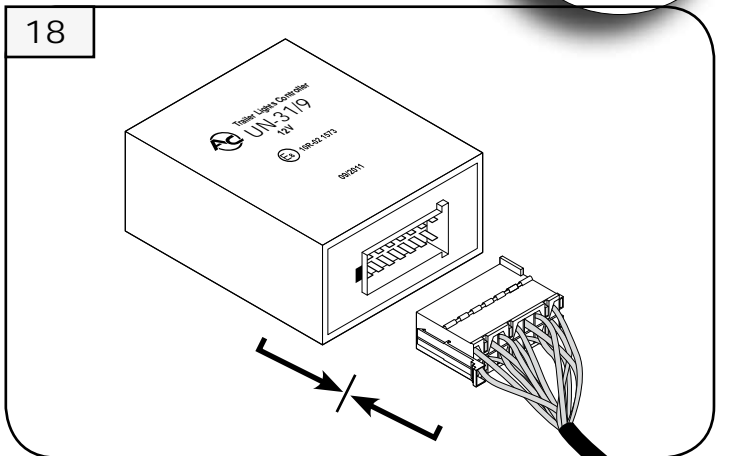
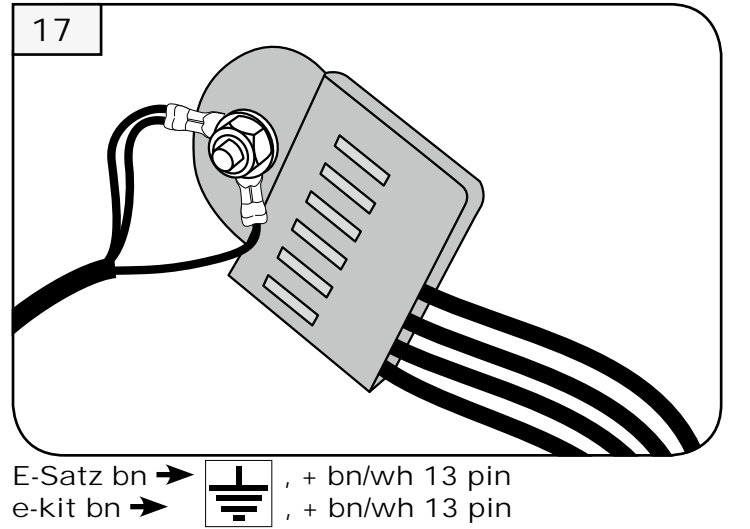
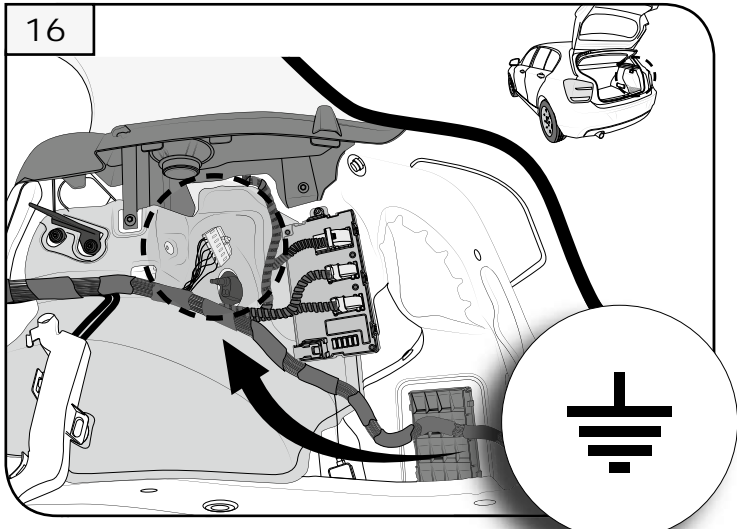

Modul UN-31/9 → Stecker 14 pin E-Satz
 modul UN-31/9 → socket 14 pin e-kit

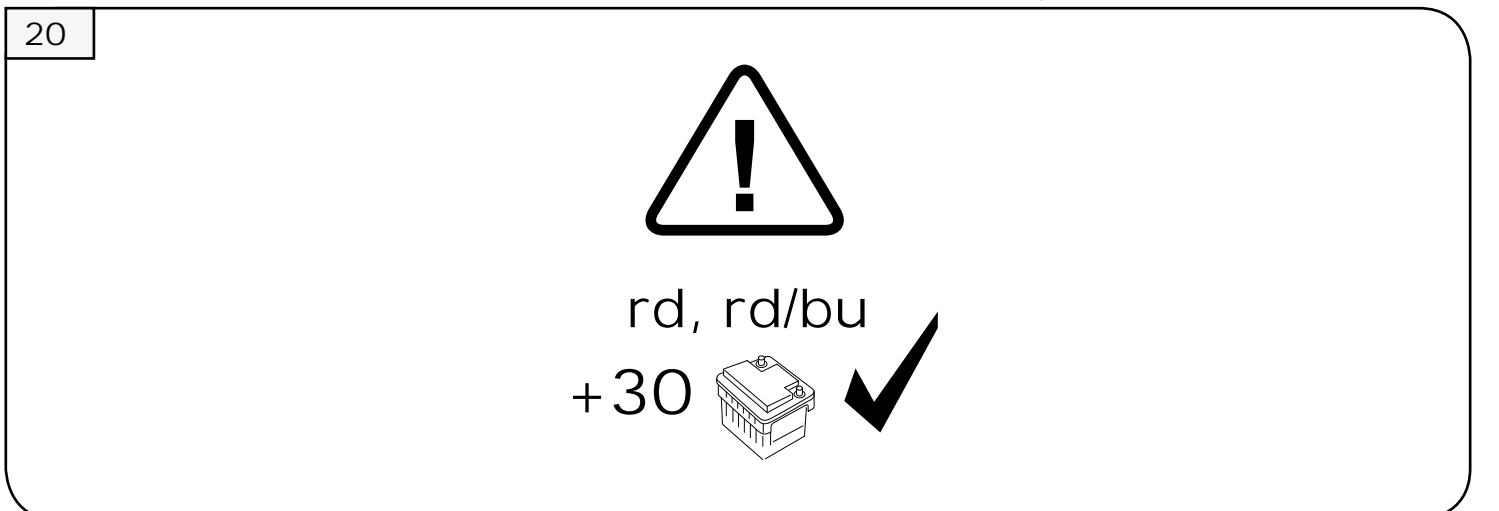
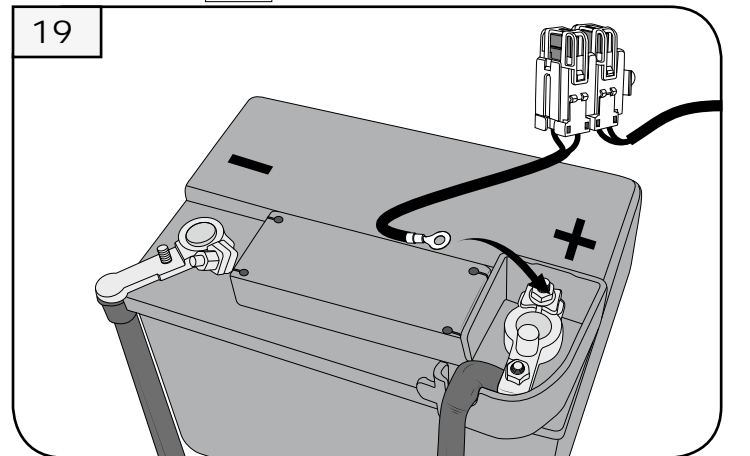

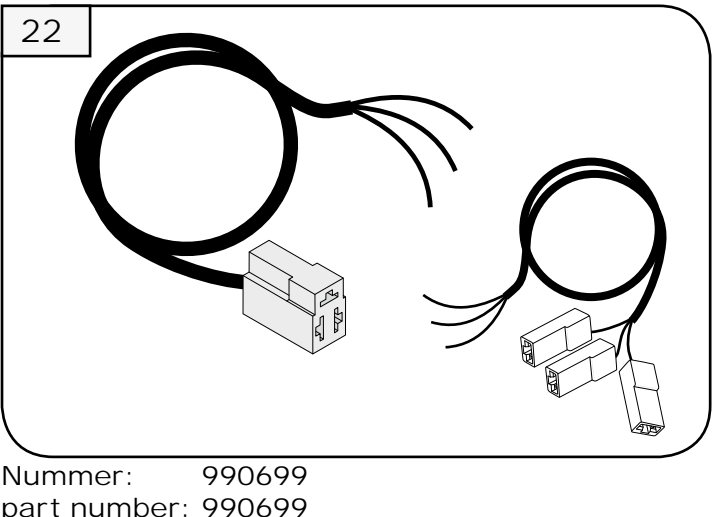
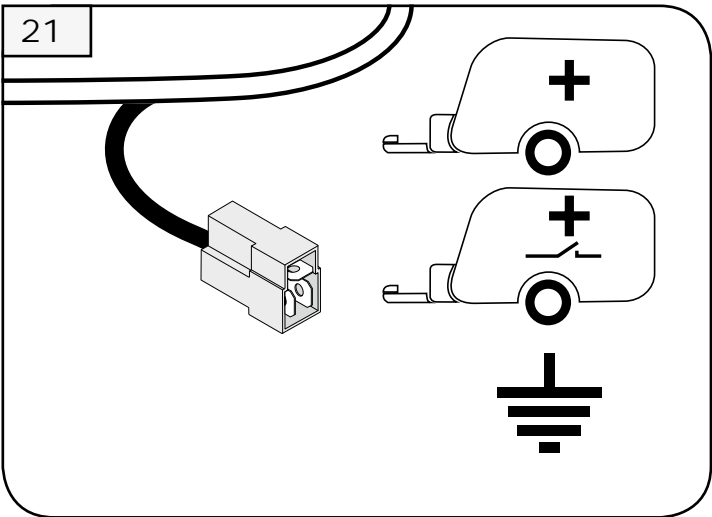

Nummer: 990699
part number: 990699

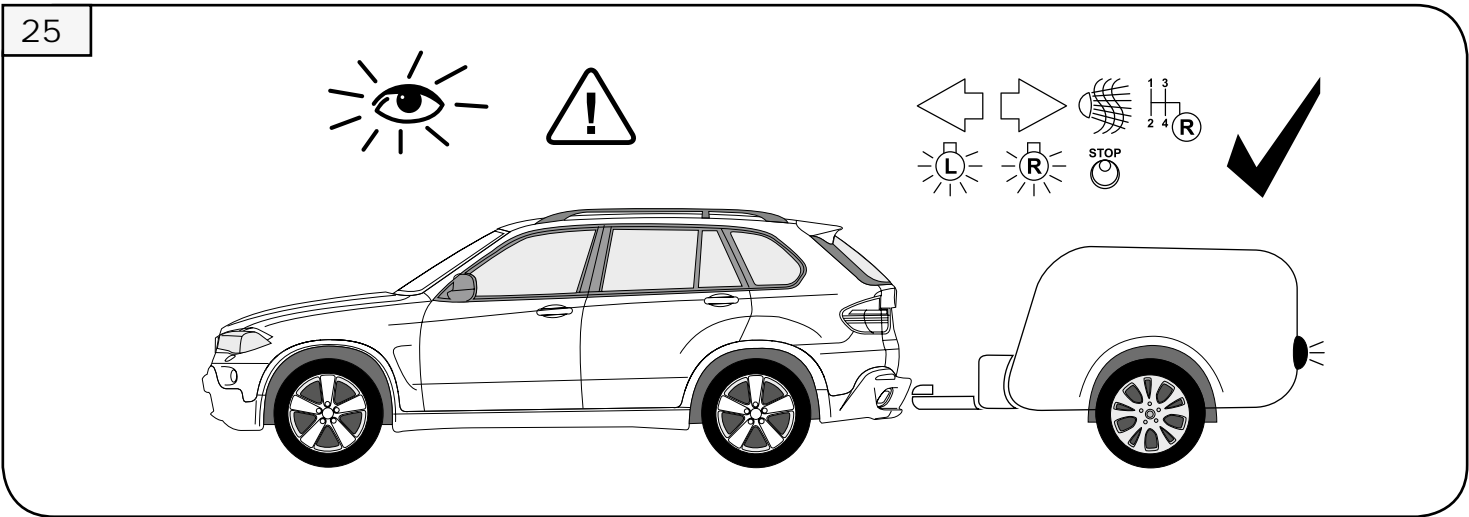
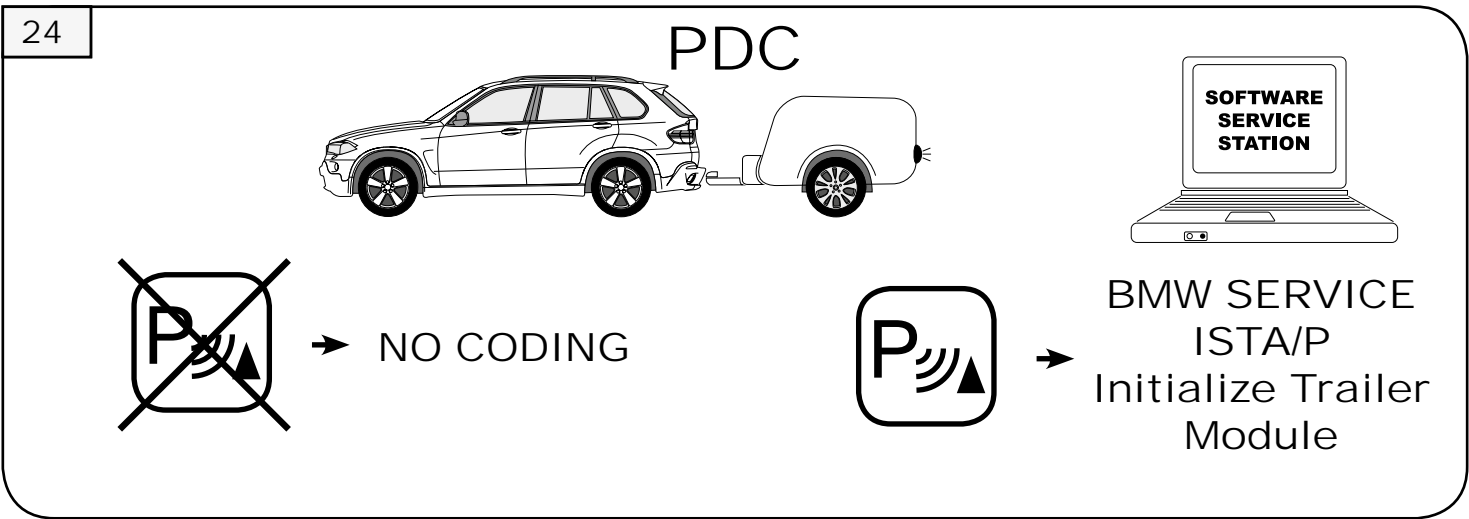
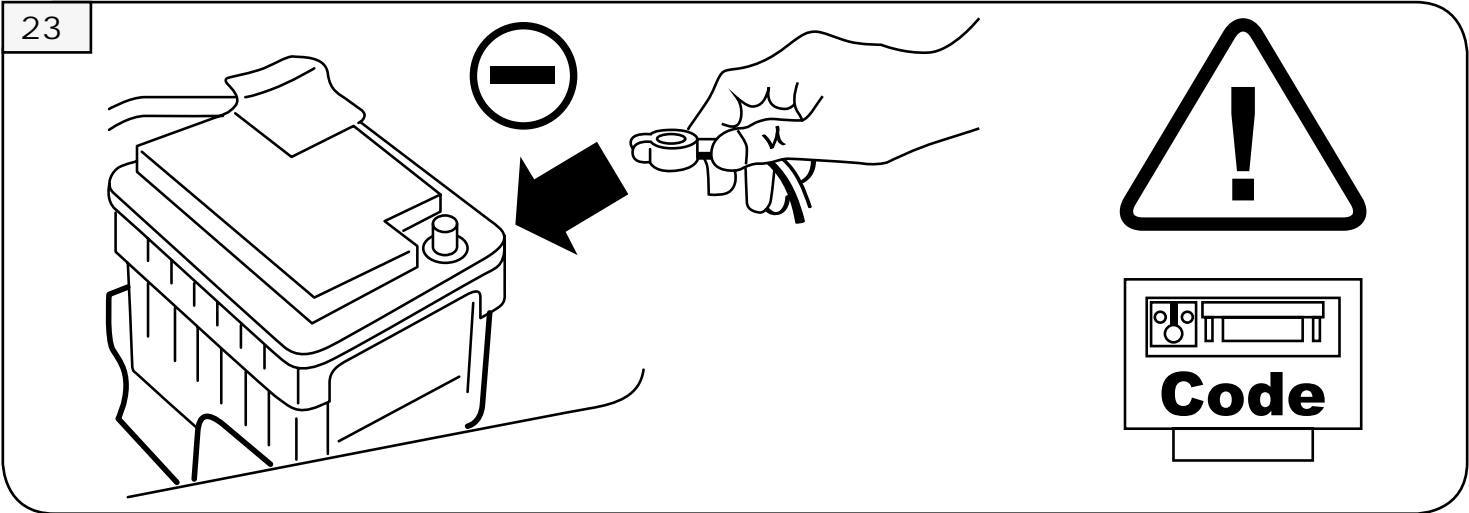

26

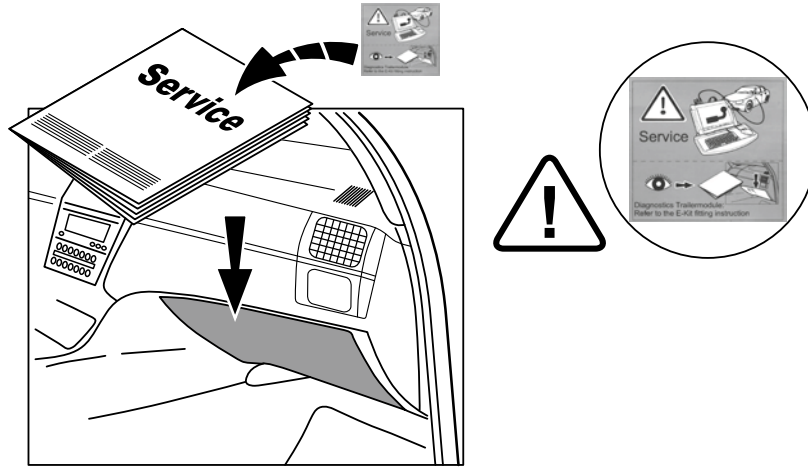

27

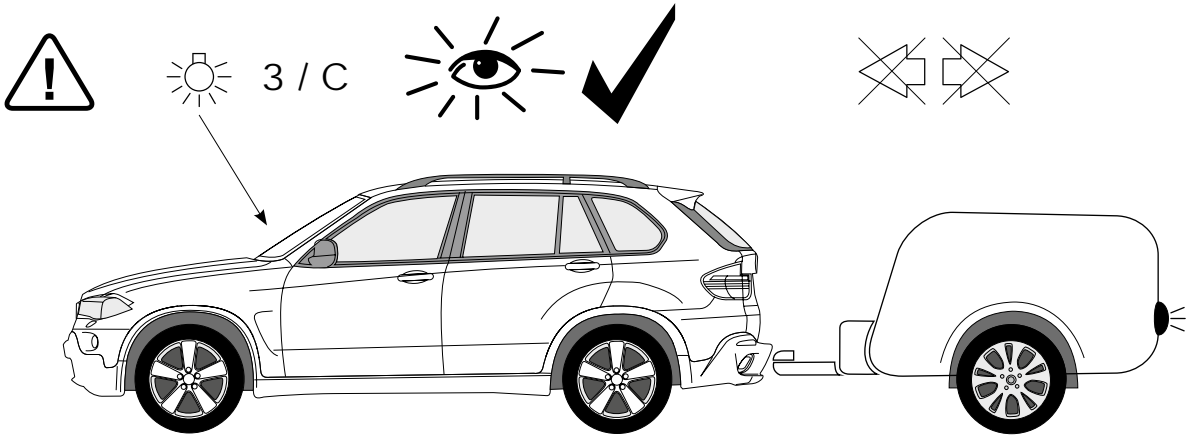

No. 043007-13

BMW F30 Bj. 03.14-



BMW F31 Bj. 03.14-

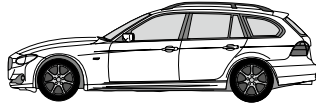

BMW F32 Bj. 03.14-

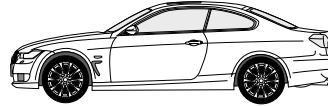

BMW F33 Bj. 03.14-

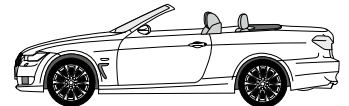

BMW F34 Bj. 03.14-



BMW F36 Bj. 03.14-

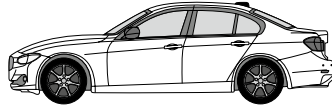

KIT 043007

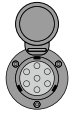

KIT 043013



- (D)** Elektrischer Anbausatz für Anhängerkupplung
- (GB)** Electrical Set for Trailer Connection
- (F)** Ensemble électrique pour brancher le crochet d'attelage
- (NL)** Elektrische aansluitset voor trekhaak
- (DK)** Elektrisk tilslutningssæt for trakkrog
- (N)** Elektrisk monteringssett for tilhengerkontakt
- (S)** Elektrisk förbindelsebyggsats av bogseringskrok
- (FIN)** Hinauskoukun sähköliitännäpaketti
- (I)** Kit di congiunzione del gancio per rimorchio
- (E)** Juego de conexión eléctrica de gancho de remolque
- (CZ)** Elektrická připojovací sestava tažného zařízení
- (H)** Elektromos kábelköteg vonóhorog bekötéséhez
- (RU)** Электрический присоединительный комплект буксирного крюка
- (LT)** Elektroninis jungiamasis traukimo kablio rinkinys
- (LV)** Elektroniskais vilkšanas āķa savienojuma komplekts
- (EST)** Elektriline tiisli ühenduskomplekt
- (SK)** Elektroinštalácia pre zapojenie ťažného zariadenia
- (PL)** Elektryczny zestaw przyłączeniowy haka holowniczego

7-pin

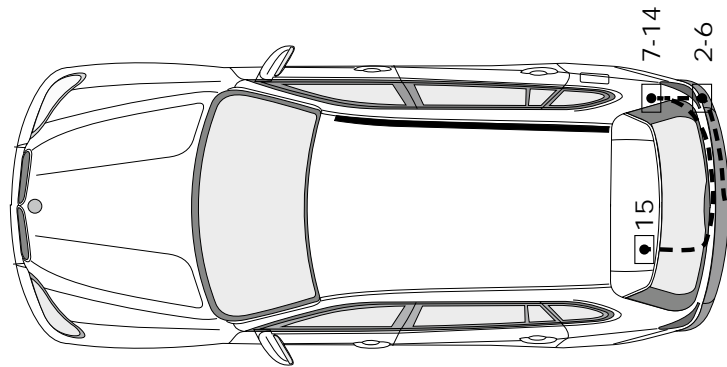
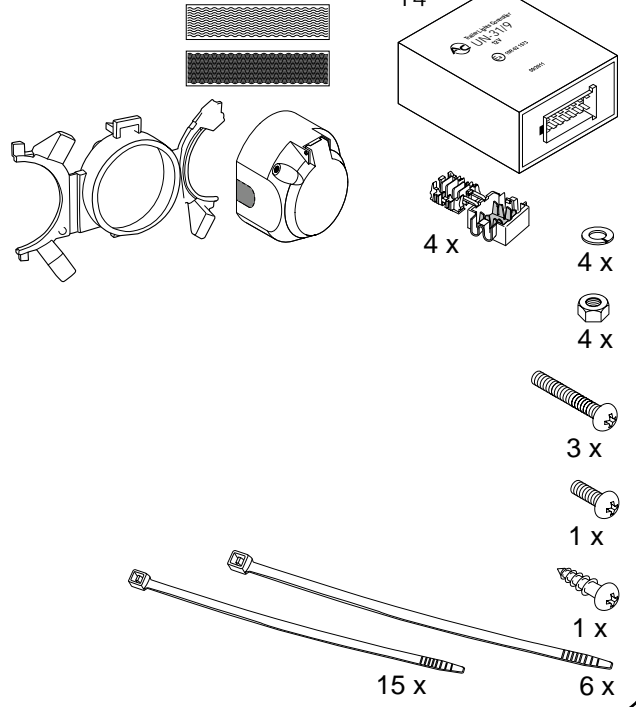
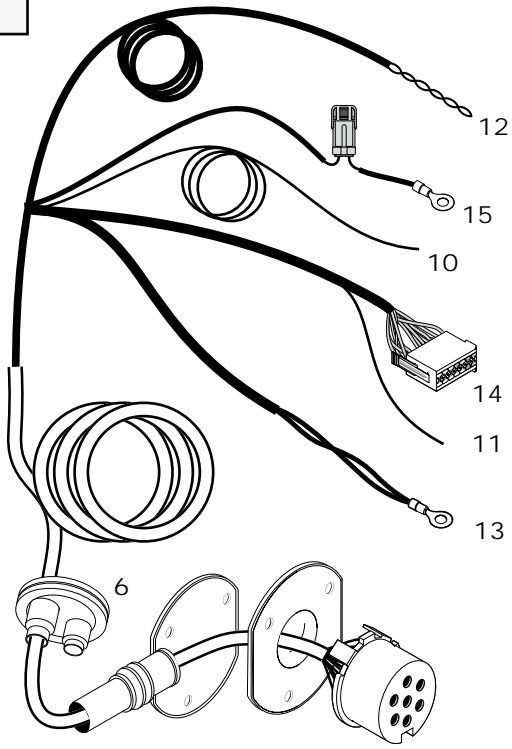

13-pin

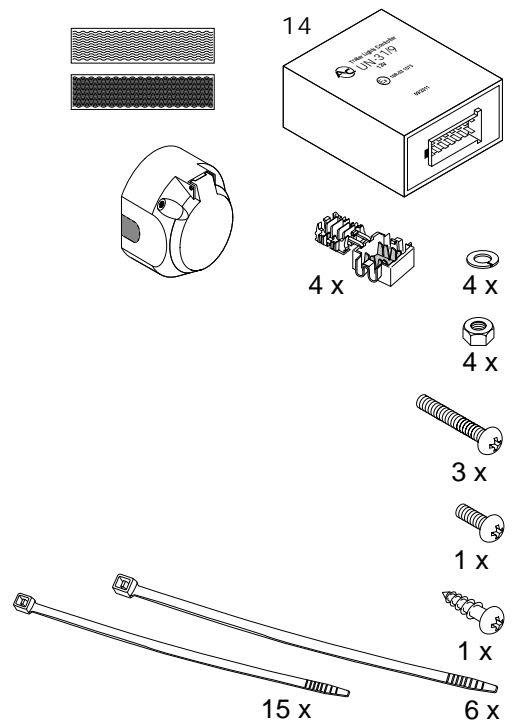
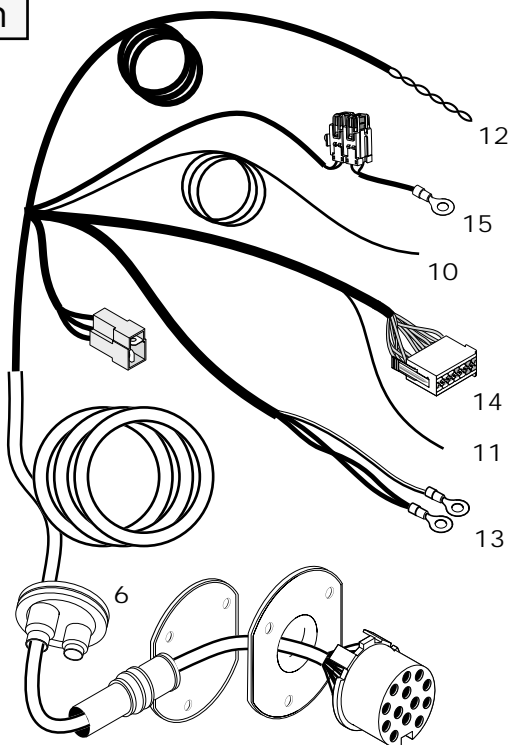

1

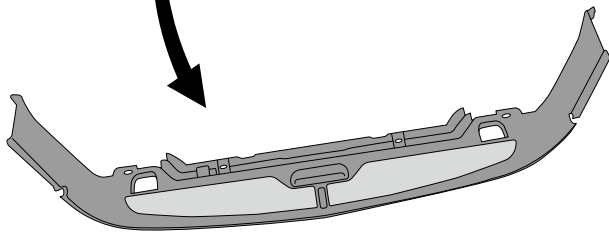
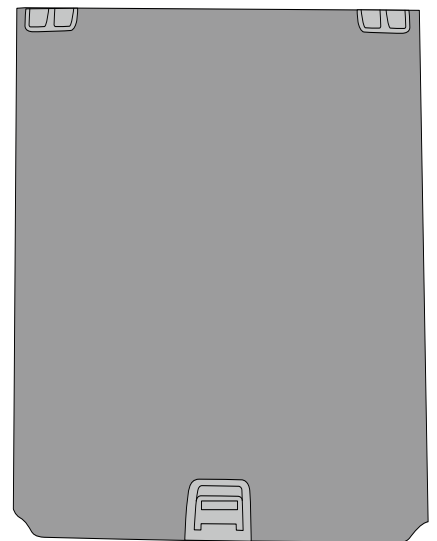
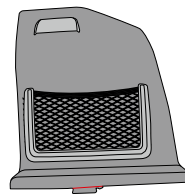
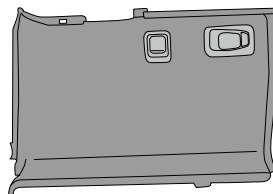
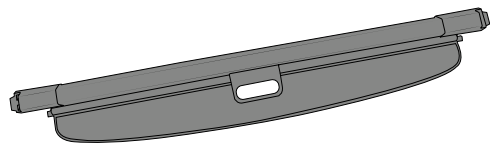
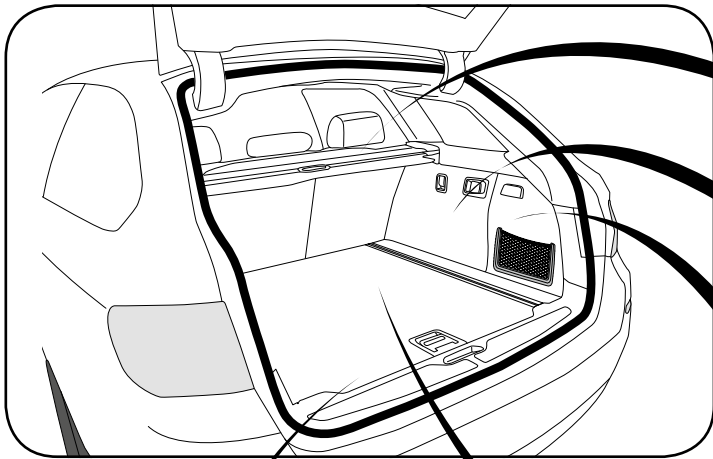
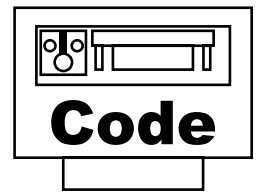
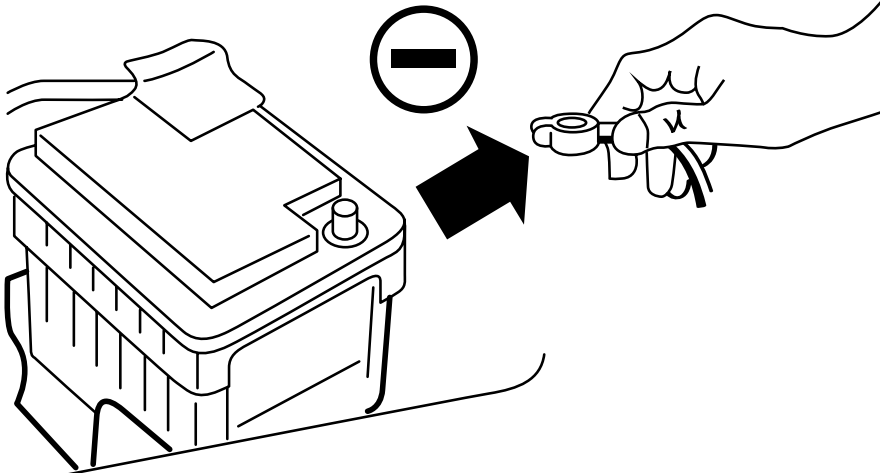

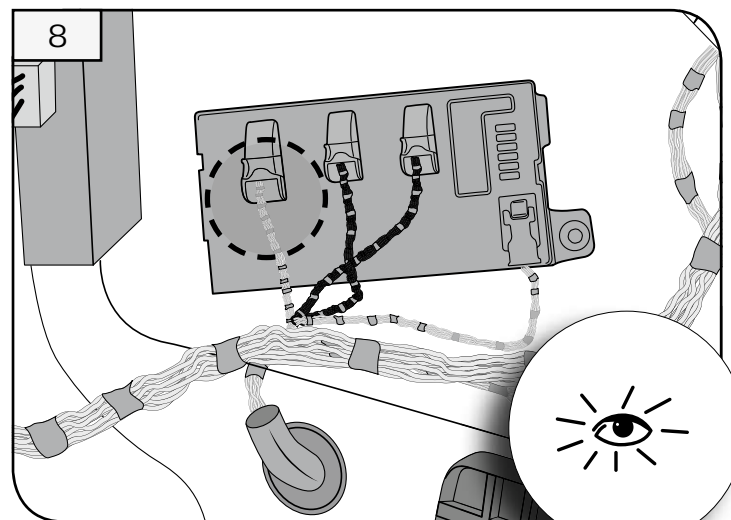
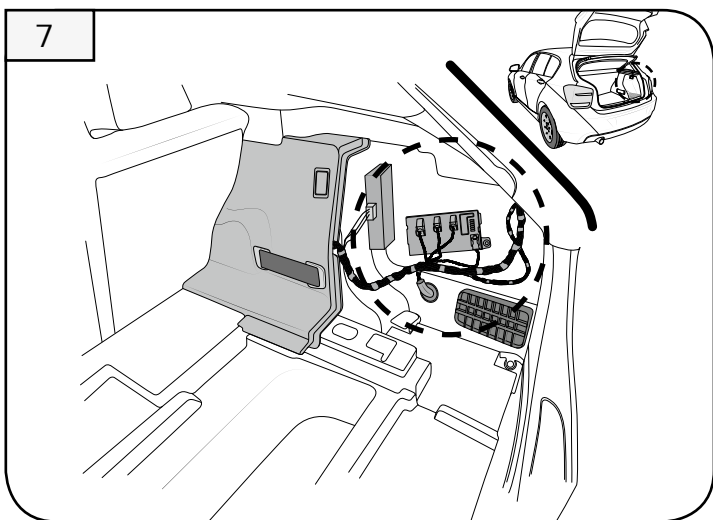
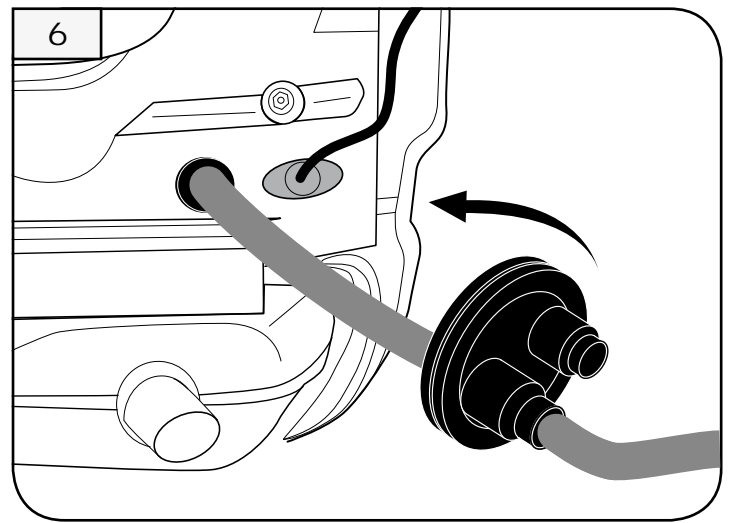
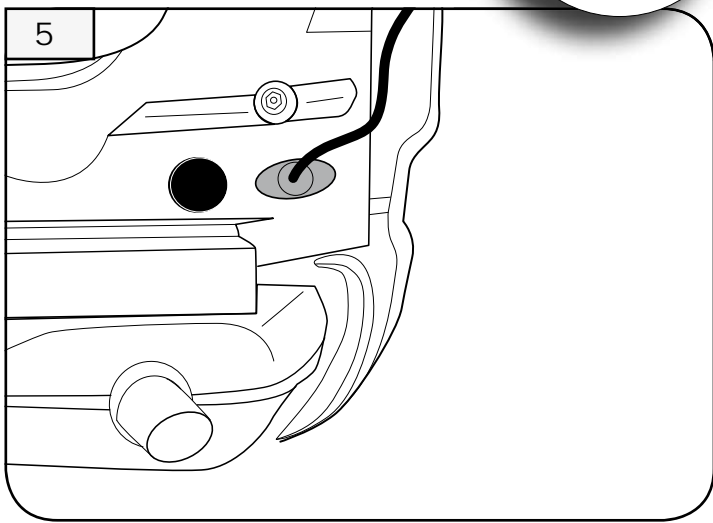
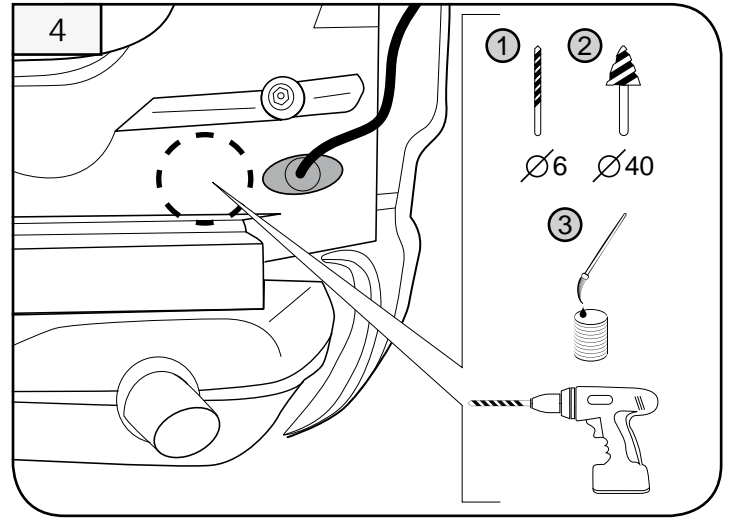
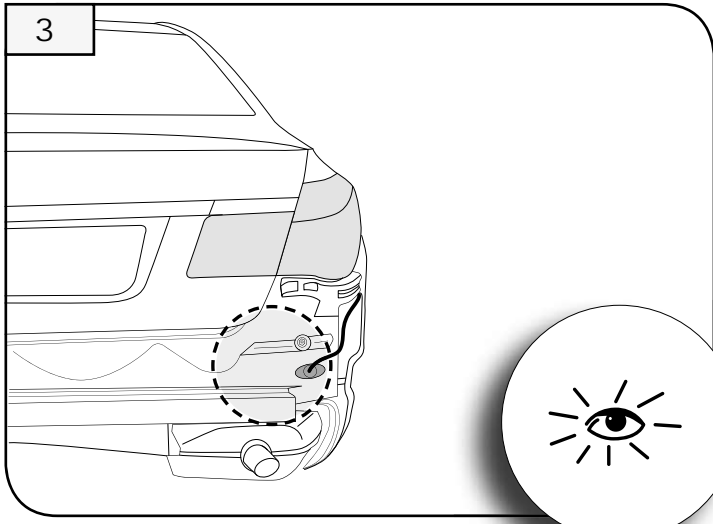
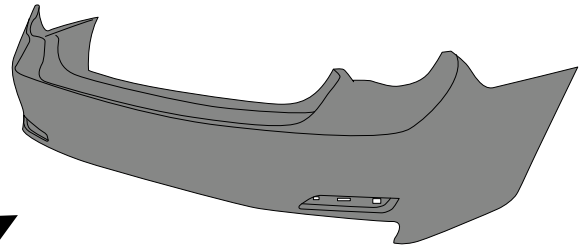
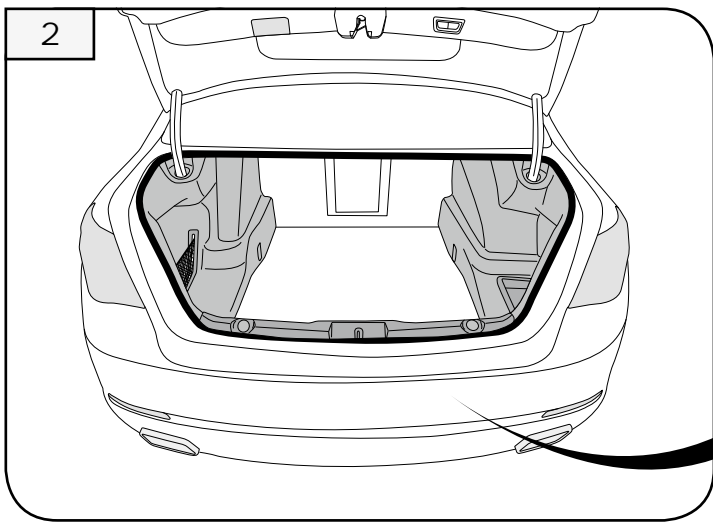

9

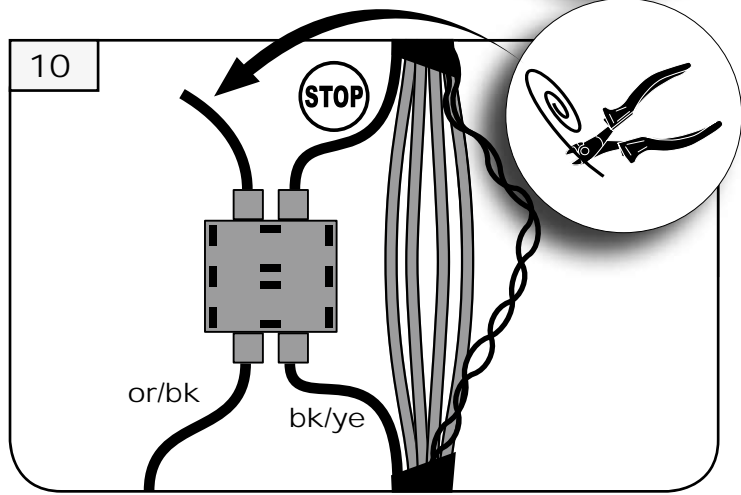
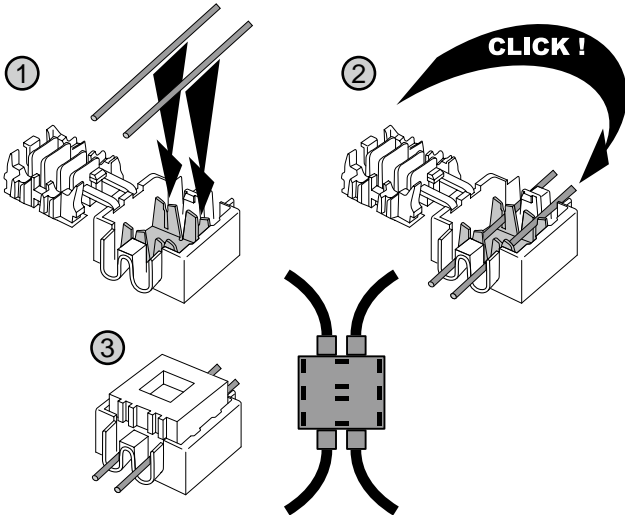
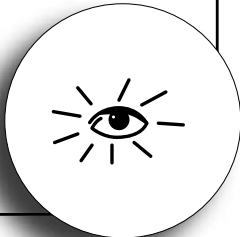
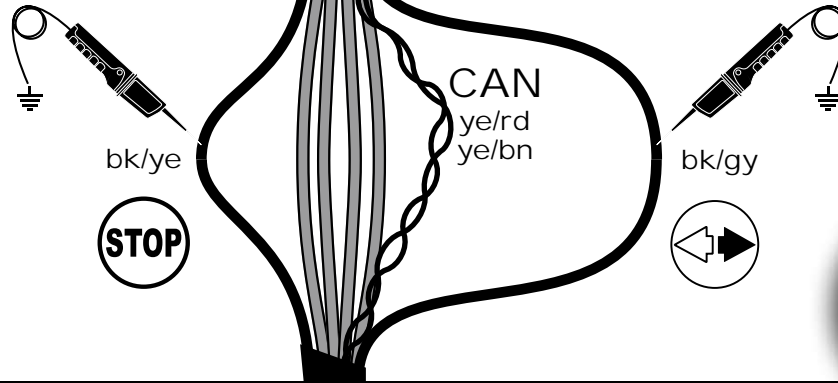

E-Satz or/bk → kabel bk/ye
 e-kit or/bk → cabel car bk/ye

11

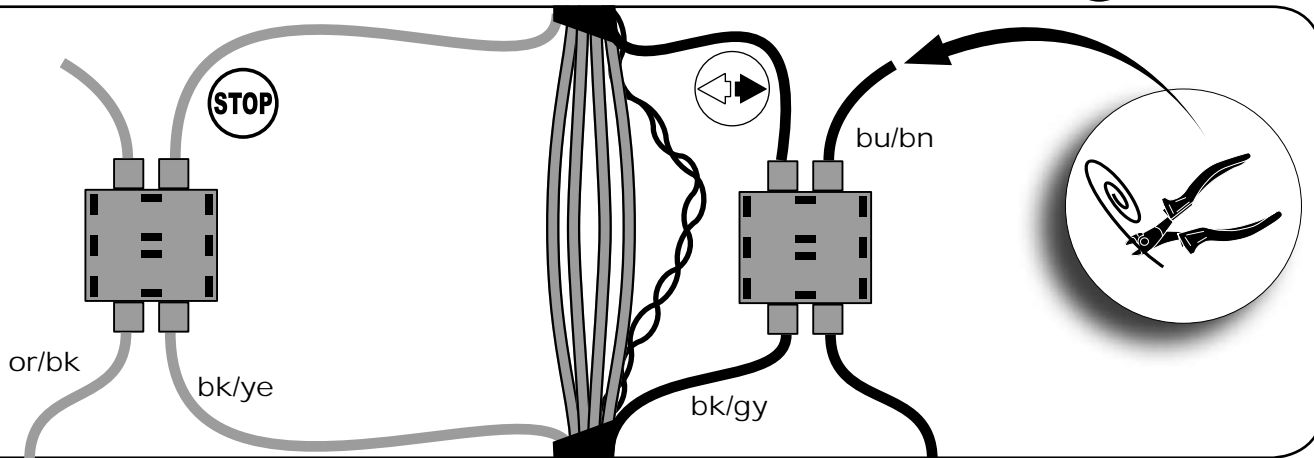

E-Satz bu/bn → kabel bk/gy
 e-kit bu/bn → cabel car bk/gy

12

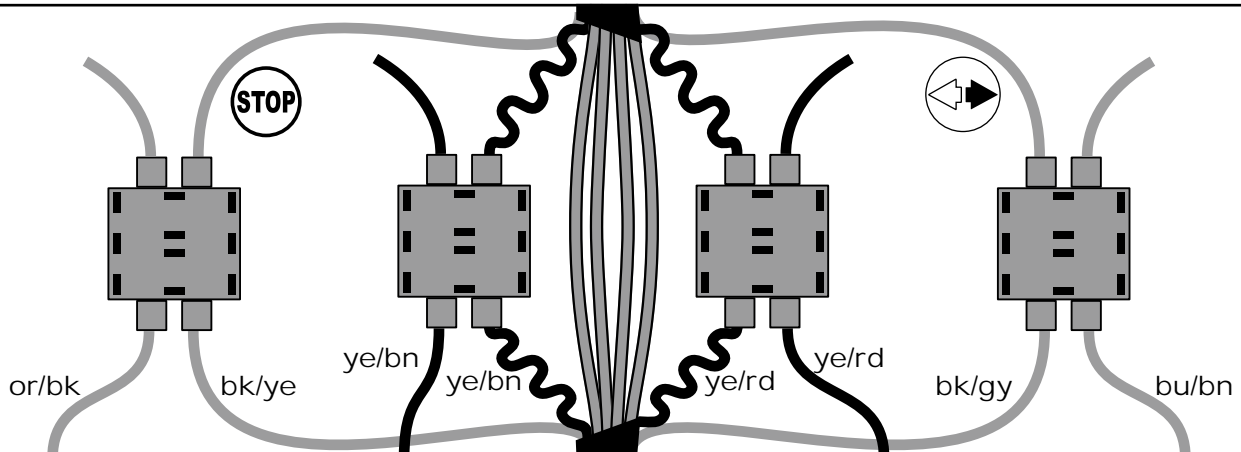

E-Satz ye/bn → kabel ye/bn, E-Satz ye/rd → kabel ye/rd
 e-kit ye/bn → cabel car ye/bn, e-kit ye/rd → cabel car ye/rd

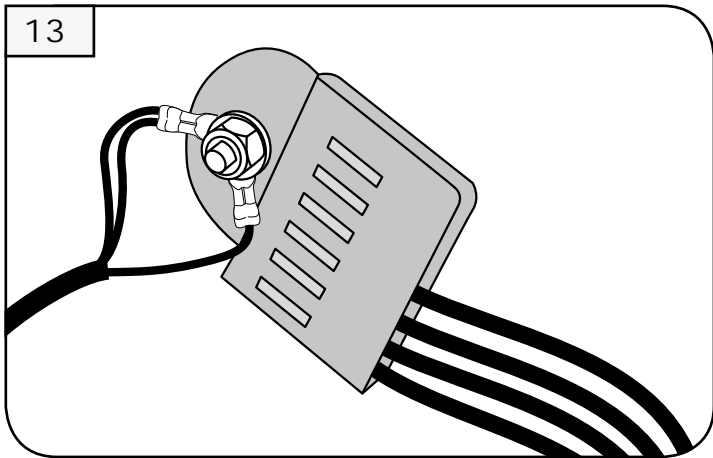

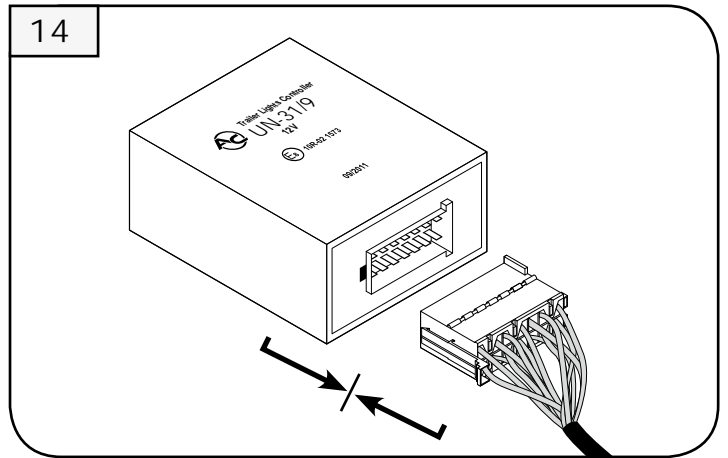

E-Satz bn →  , + bn/wh 13 pin
 e-kit bn →  , + bn/wh 13 pin

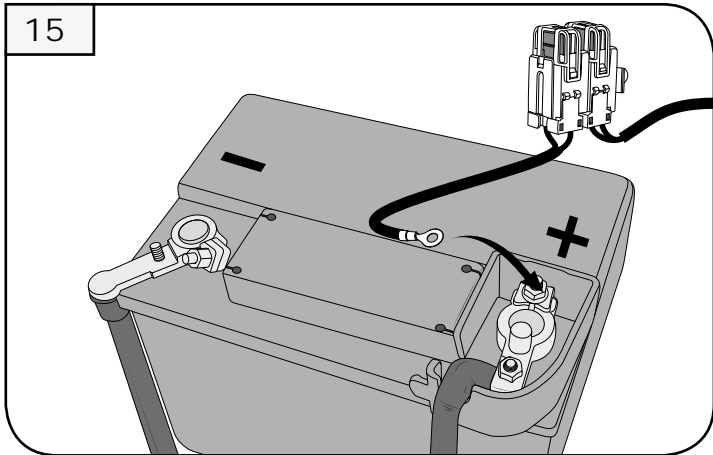

Modul UN-31/9 → Stecker 14 pin E-Satz
 modul UN-31/9 → socket 14 pin e-kit



E-Satz rd +30 →  + rd/bu 13 pin
 e-kit rd+30 →  + rd/bu 13 pin

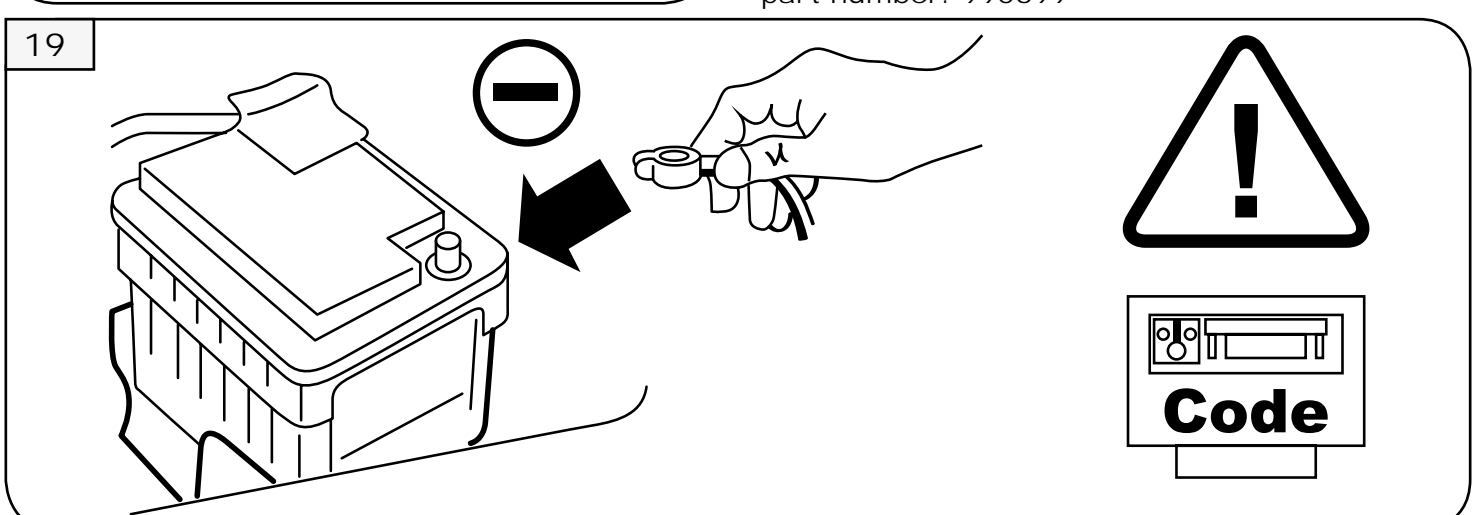
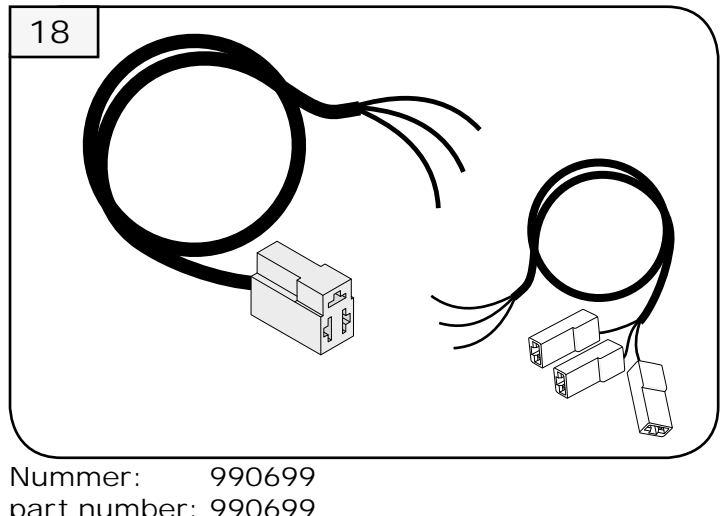
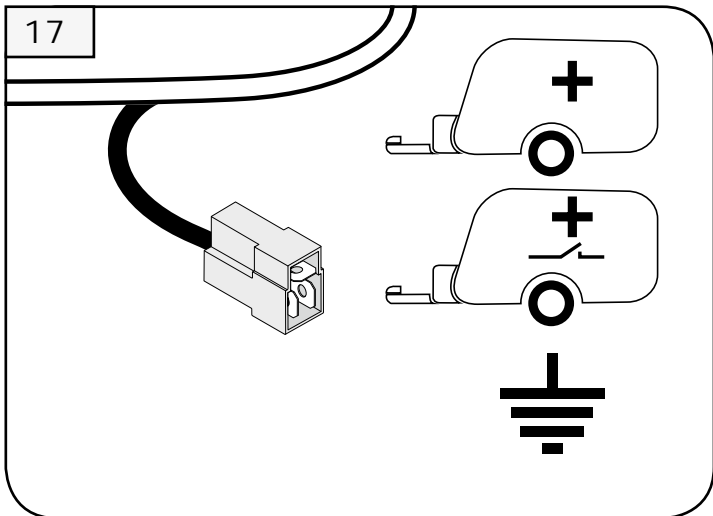
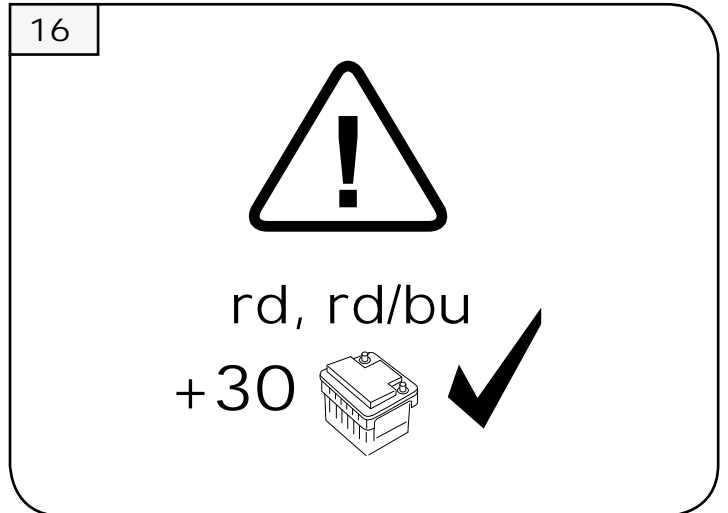

20

PDC

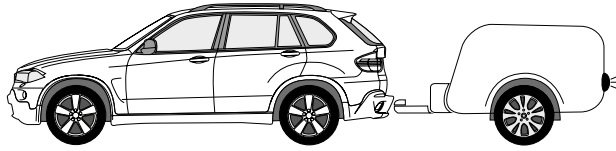

➔ NO CODING



➔ BMW SERVICE ISTA/P Initialize Trailer Module

21

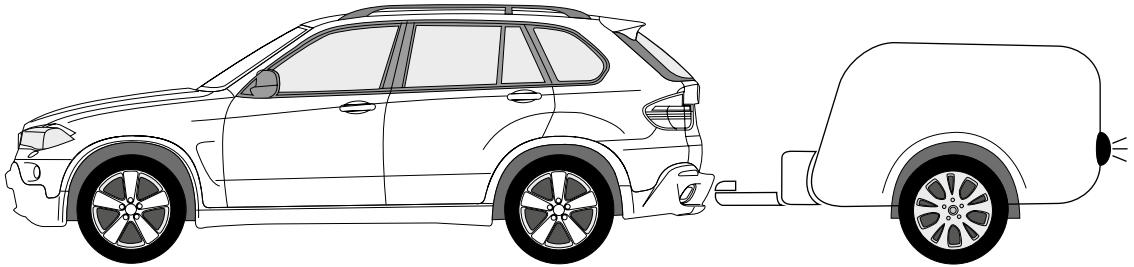
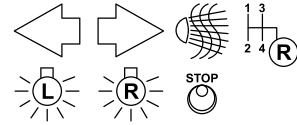

22

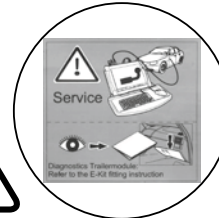
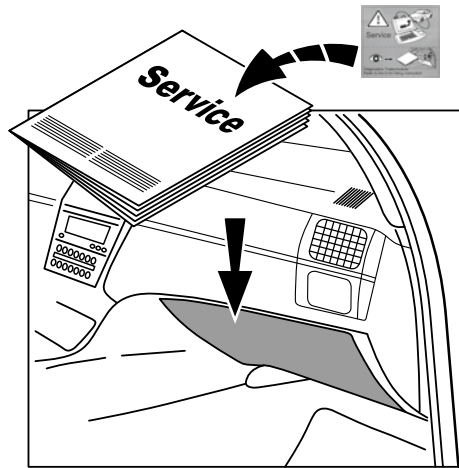

23



3 / C

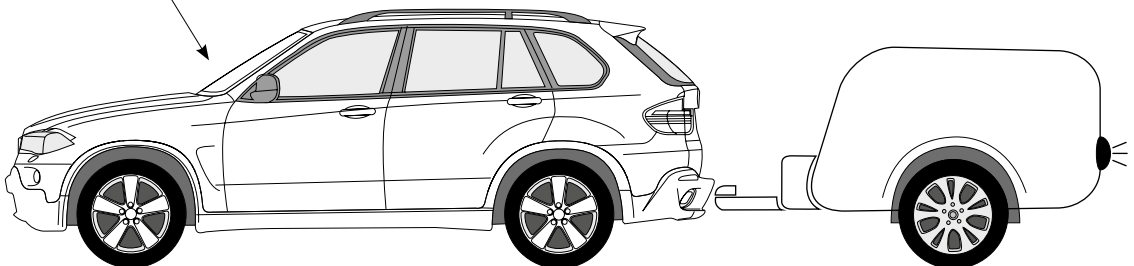
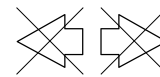

No. 043007-13

BMW F07 Bj. 01.14-



BMW F10 Bj. 03.14-



BMW F11 Bj. 03.14-

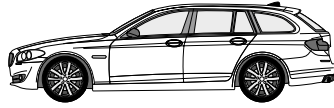

BMW F01/F02 Bj. 03.14-

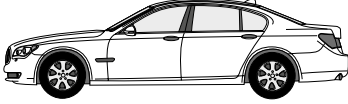

KIT 043007

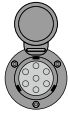

KIT 043013



- (D)** Elektrischer Anbausatz für Anhängerkupplung
- (GB)** Electrical Set for Trailer Connection
- (F)** Ensemble électrique pour brancher le crochet d'attelage
- (NL)** Elektrische aansluitset voor trekhaak
- (DK)** Elektrisk tilslutningssæt for trakkrog
- (N)** Elektrisk monteringssett for tilhengerkontakt
- (S)** Elektrisk förbindelsebyggsats av bogseringskrok
- (FIN)** Hinauskoukun sähköliitäntäpaketti
- (I)** Kit di congiunzione del gancio per rimorchio
- (E)** Juego de conexión eléctrica de gancho de remolque
- (CZ)** Elektrická připojovací sestava tažného zařízení
- (H)** Elektromos kábelköteg vonóhorog bekötéséhez
- (RU)** Электрический присоединительный комплект буксирного крюка
- (LT)** Elektroninis jungiamasis traukimo kablio rinkinys
- (LV)** Elektroniskais vilkšanas āķa savienojuma komplekts
- (EST)** Elektriline tiisli ühenduskomplekt
- (SK)** Elektroinštalácia pre zapojenie ťažného zariadenia
- (PL)** Elektryczny zestaw przyłączeniowy haka holowniczego

7-pin

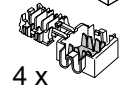
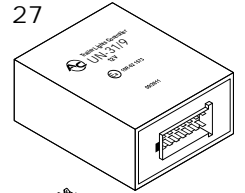
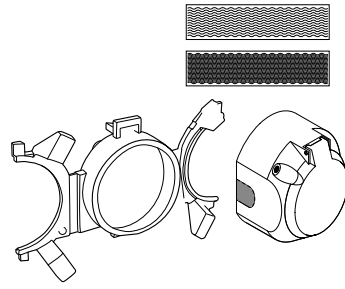
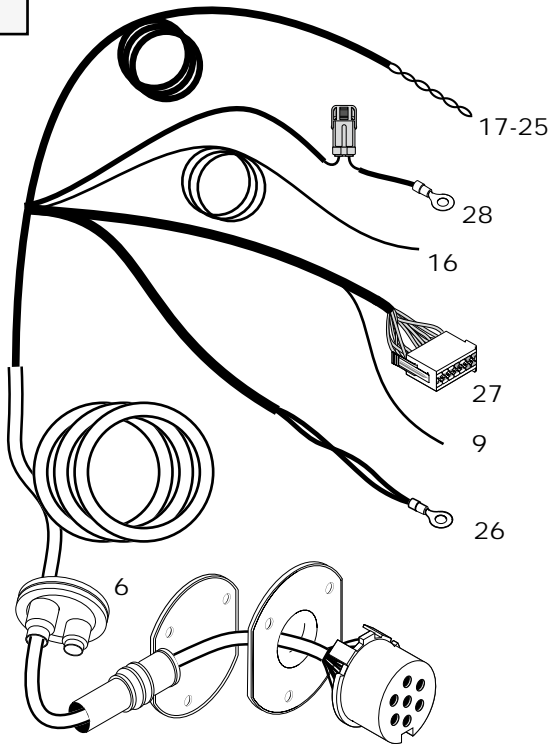

4 x

4 x

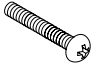

3 x



1 x



1 x

6 x

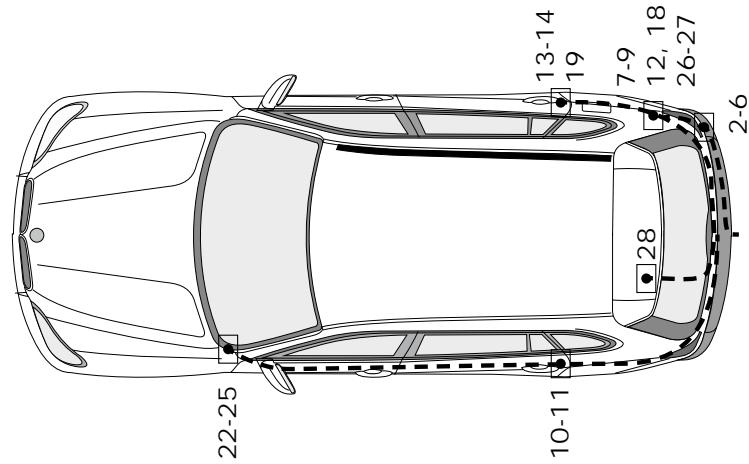
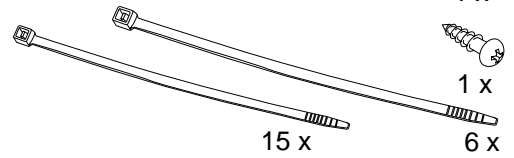

13-pin

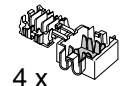
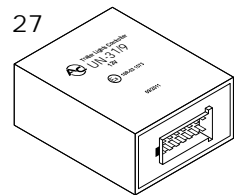
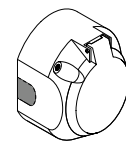
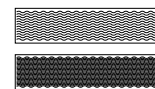
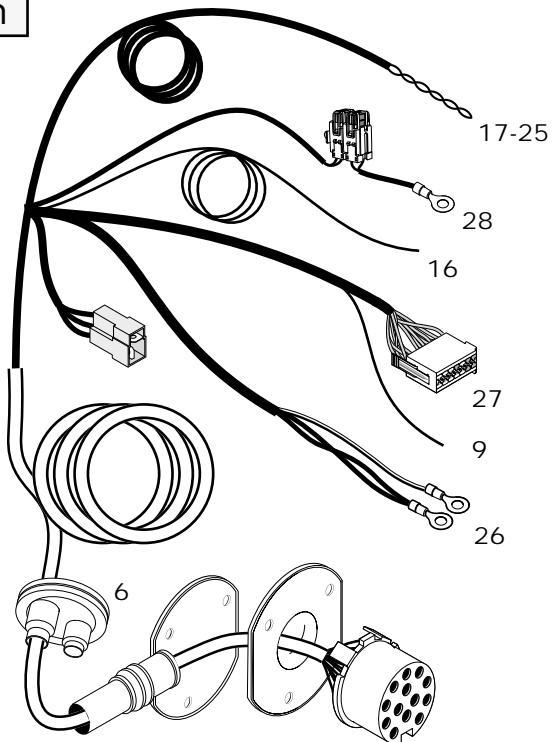

4 x

4 x

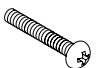

3 x



1 x



1 x

6 x

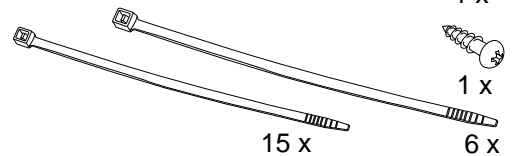

1

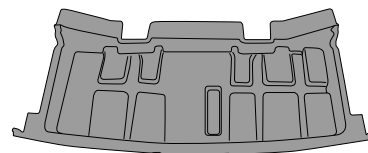
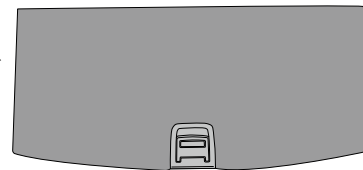
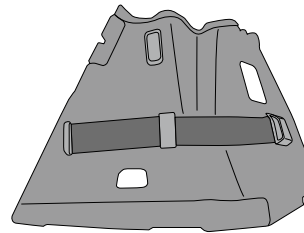
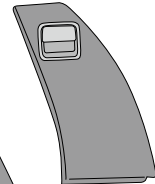
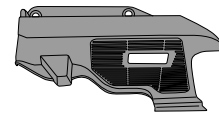
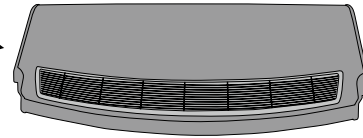
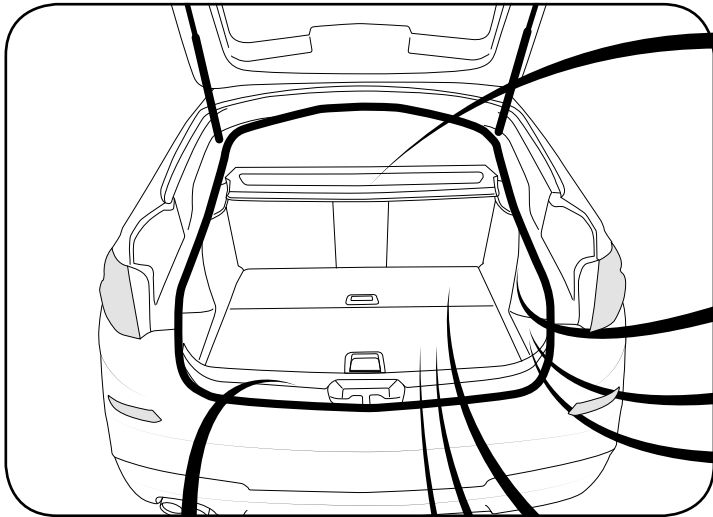
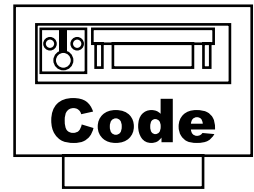
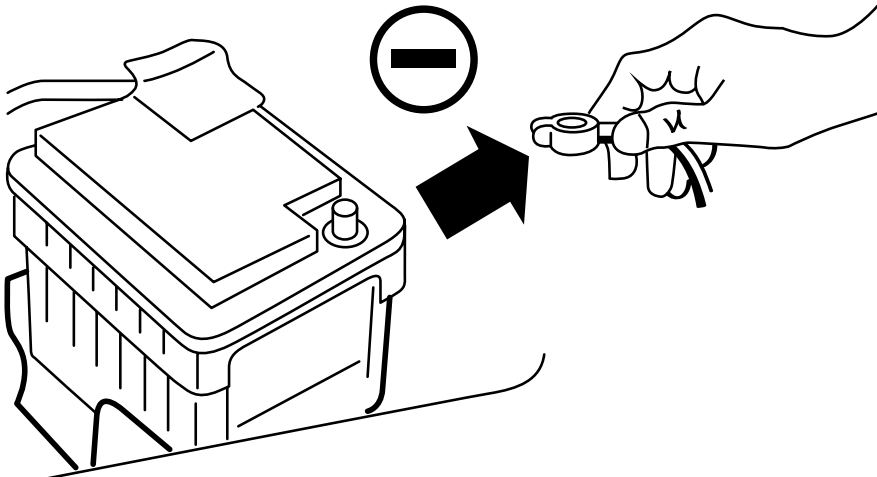

F07

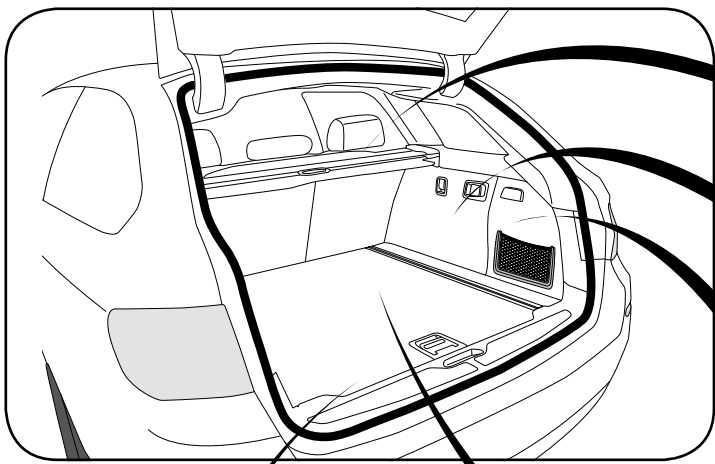

F11

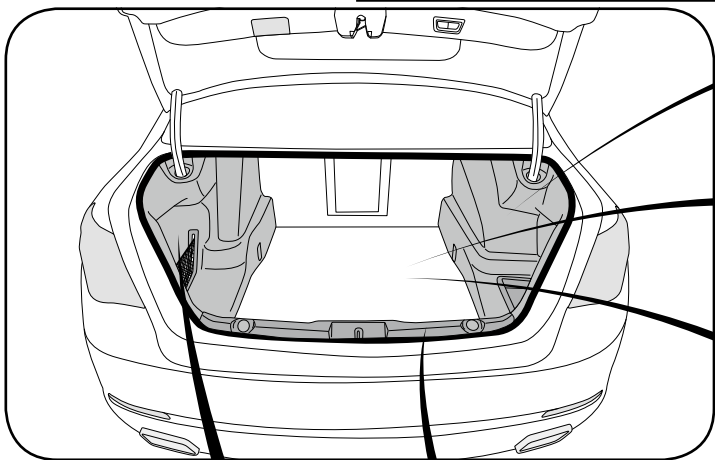
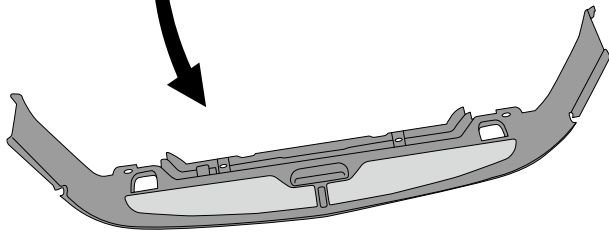
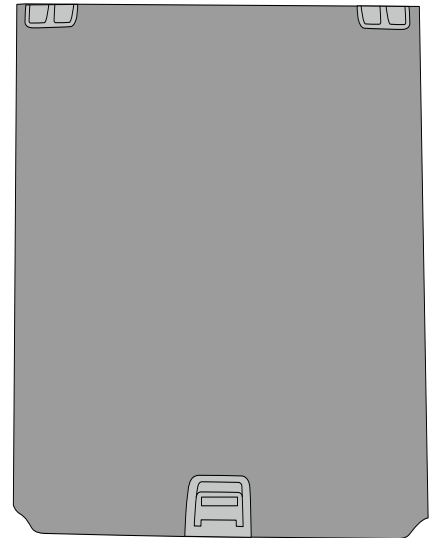
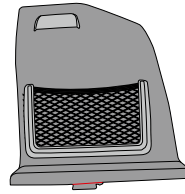
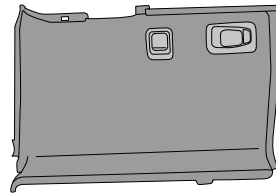
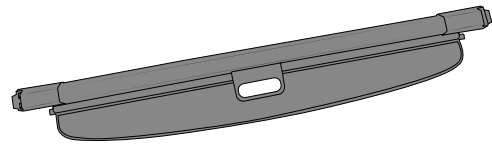

F01/ F02 / F10

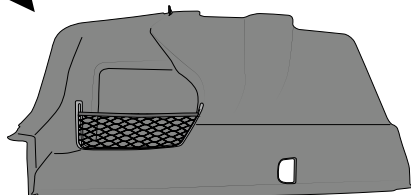
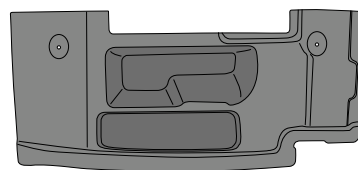
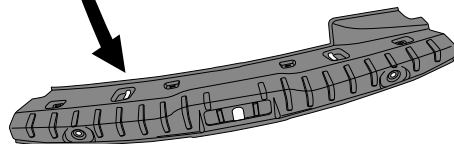
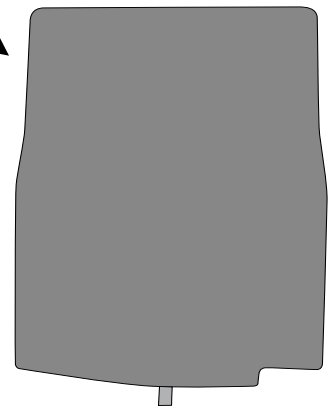
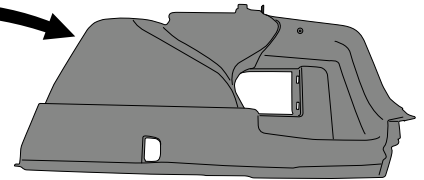

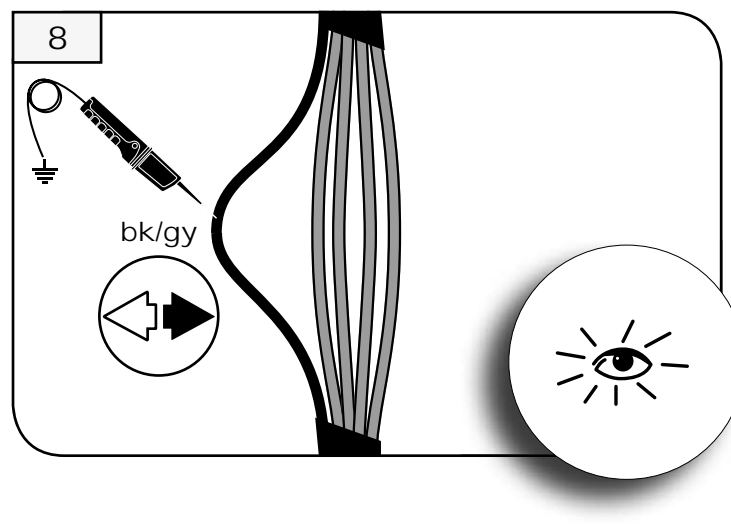
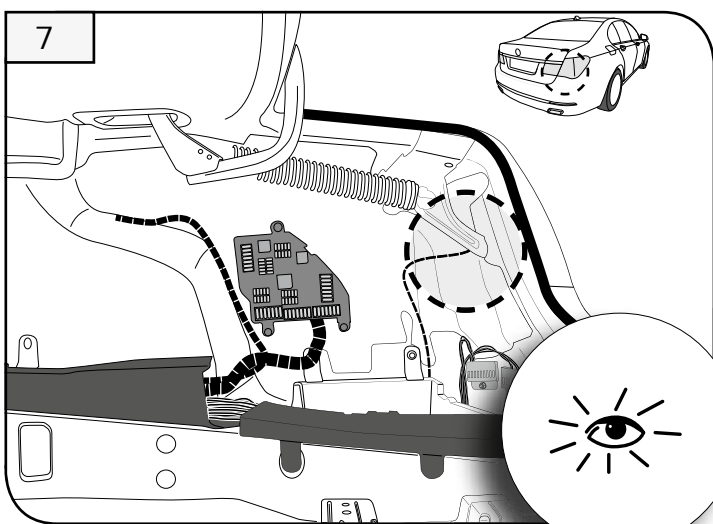
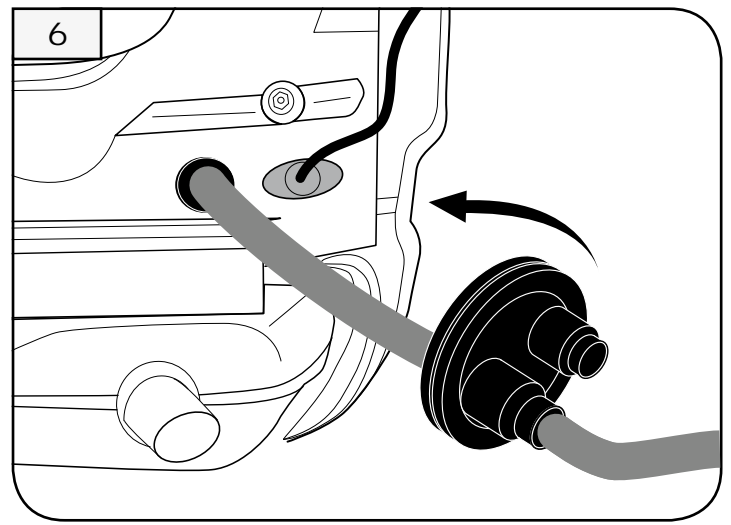
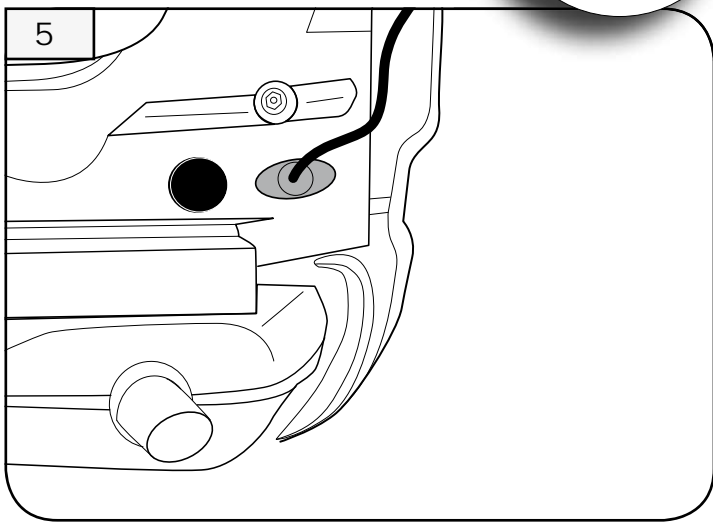
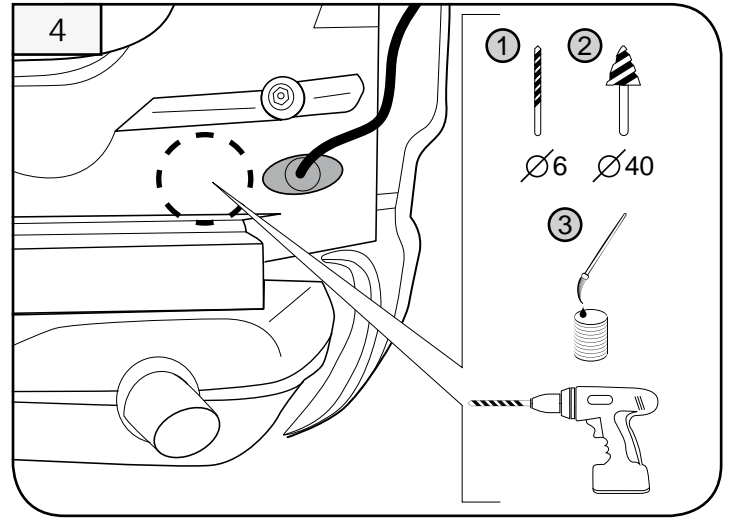
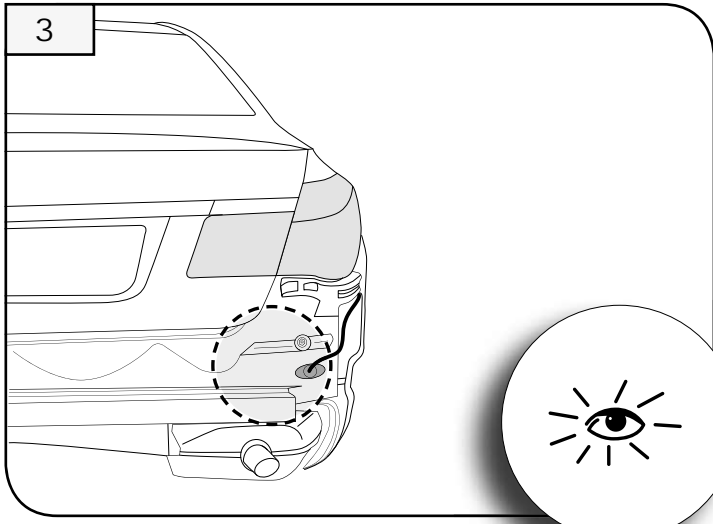
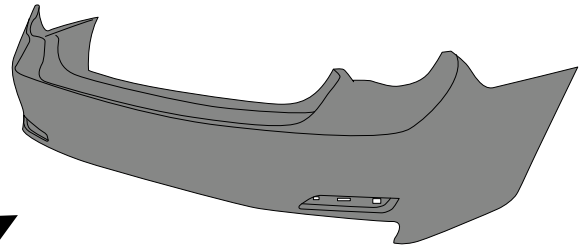
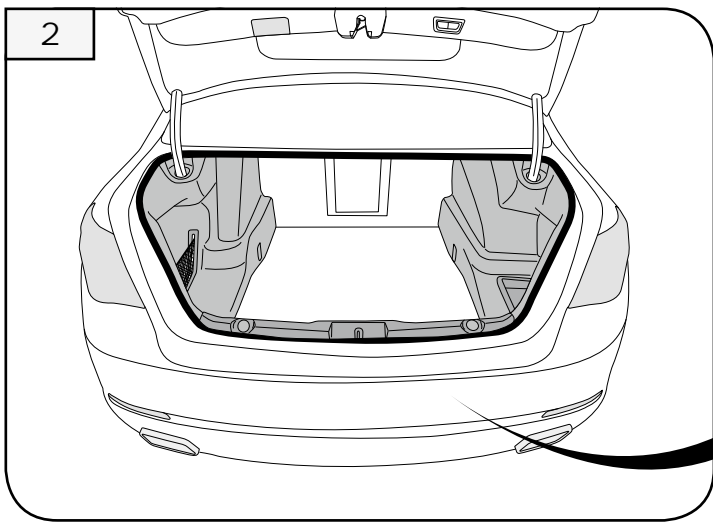

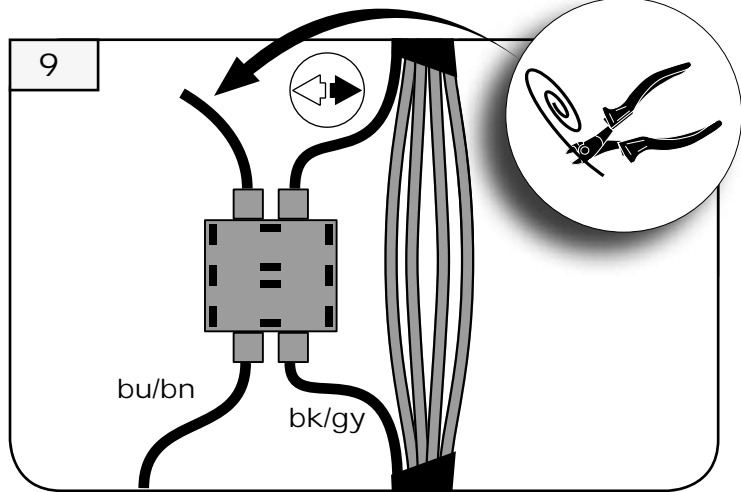
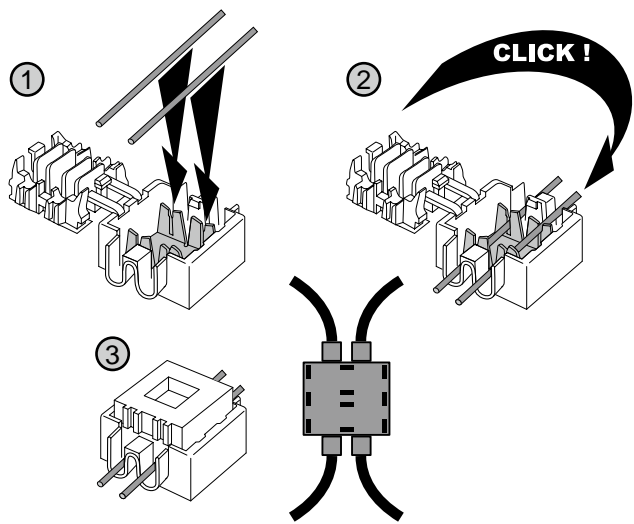

E-Satz bu/bn → kabel bk/gy
 e-kit bu/bn → cabel car bk/gy

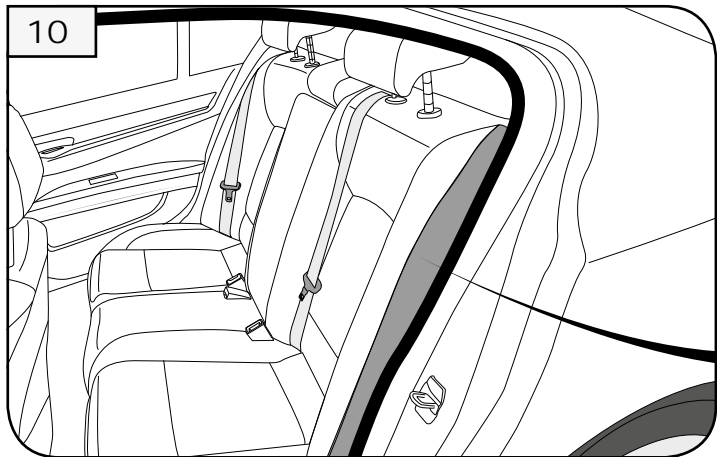

F01 / F02 / F10

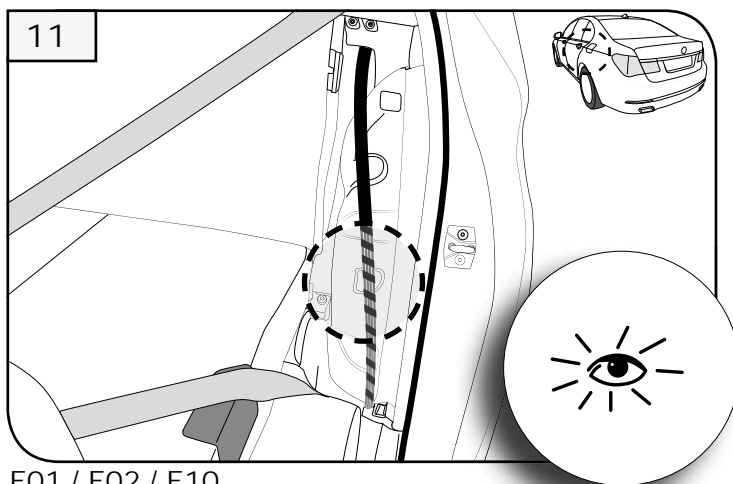
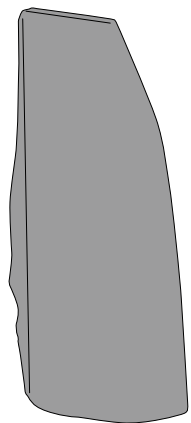

F01 / F02 / F10

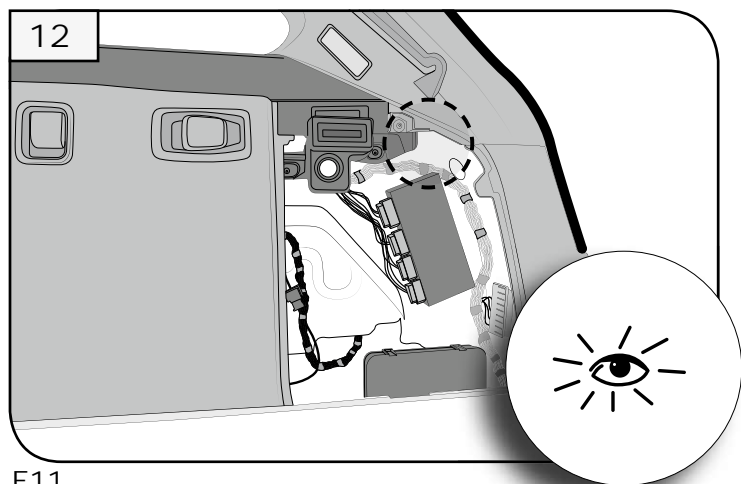

F11

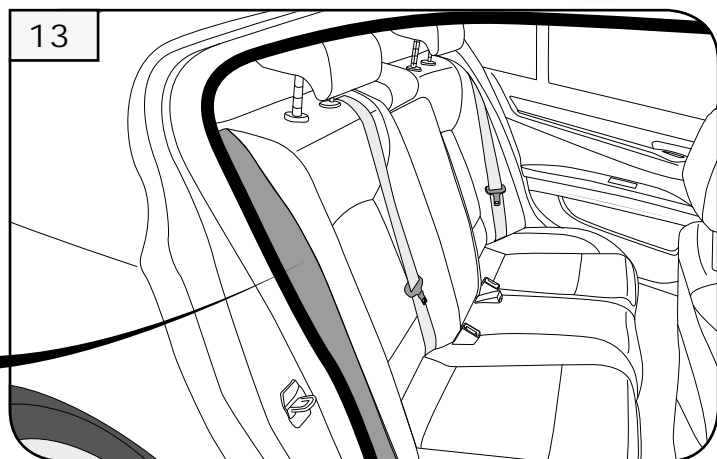
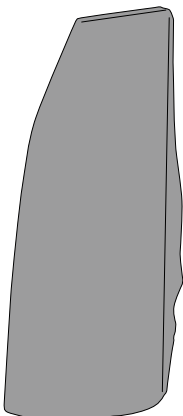

F07

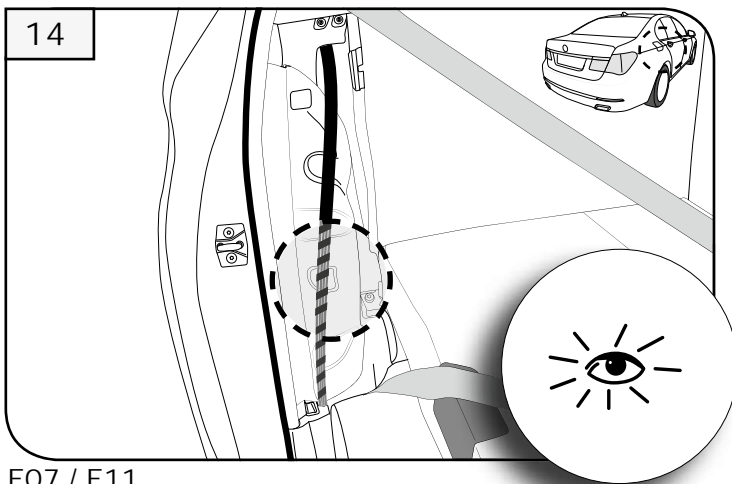

F07 / F11

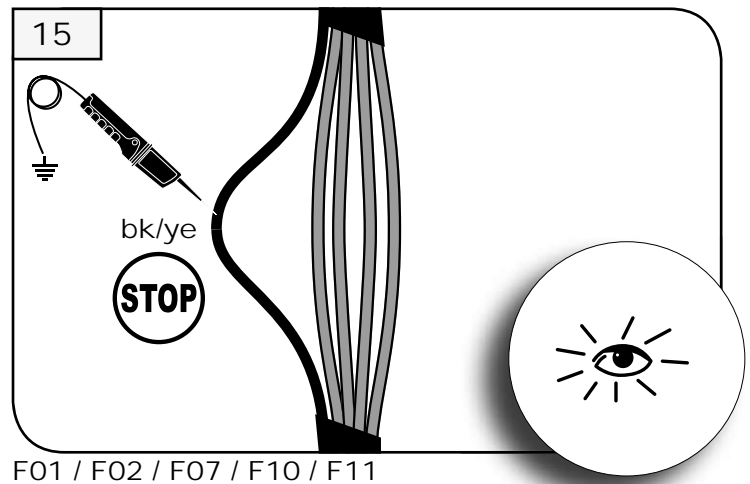

F01 / F02 / F07 / F10 / F11

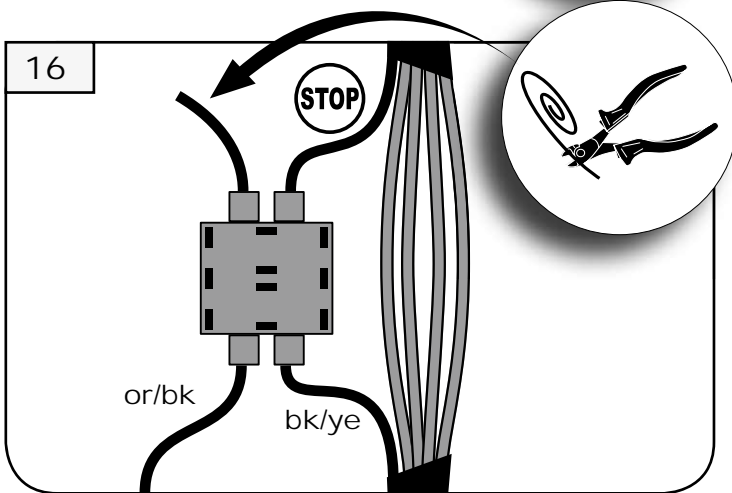

E-Satz or/bk → kabel bk/ye
 e-kit or/bk → cabel car bk/ye

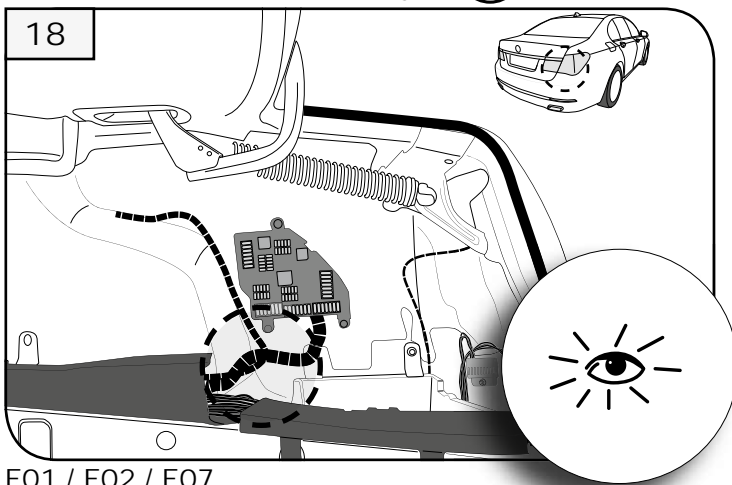
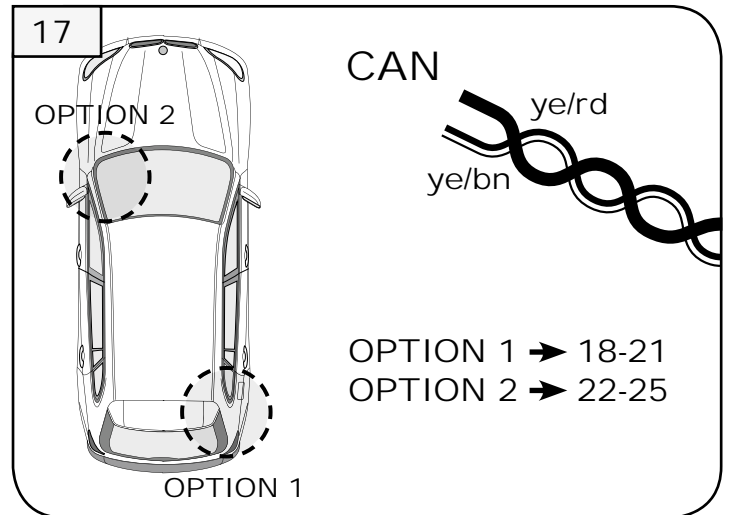

F01 / F02 / F07

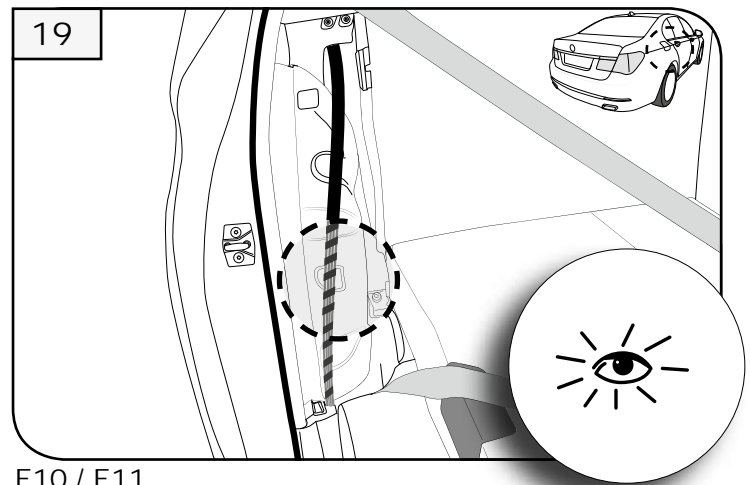

F10 / F11

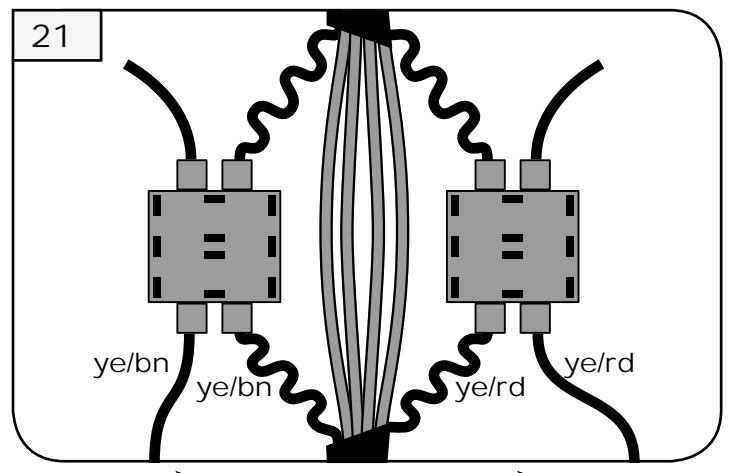
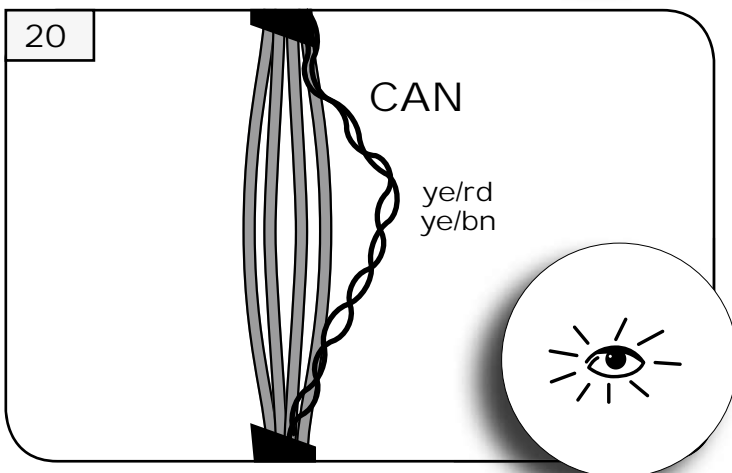

E-Satz ye/bn → kabel ye/bn, E-Satz ye/rd → kabel ye/rd
 e-kit ye/bn → cabel car ye/bn, e-kit ye/rd → cabel car ye/rd

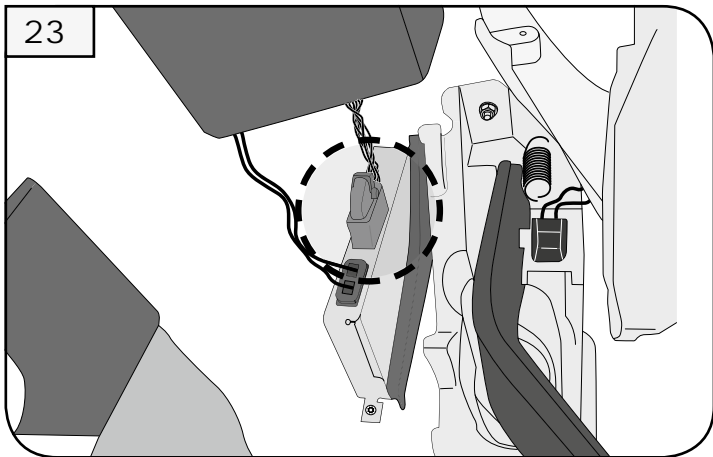
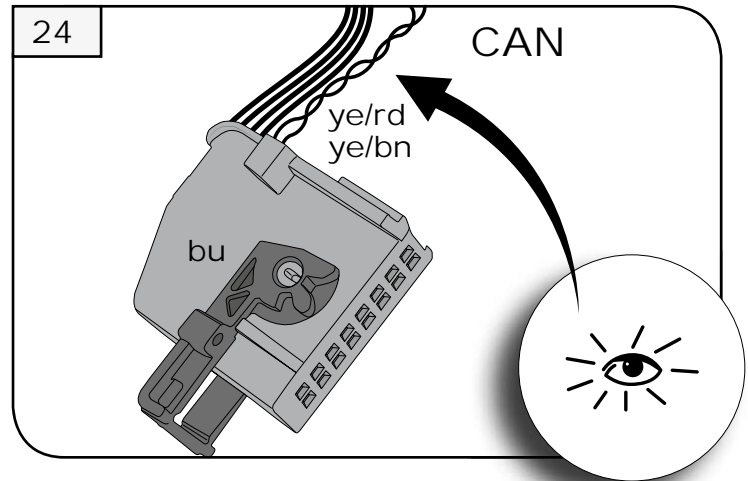
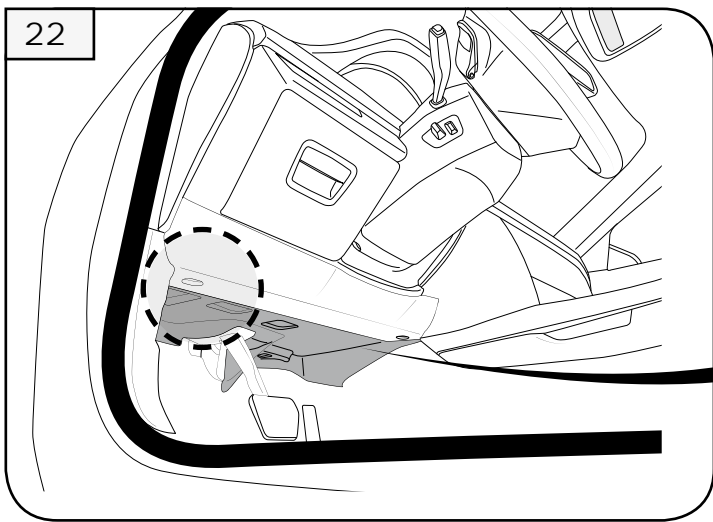

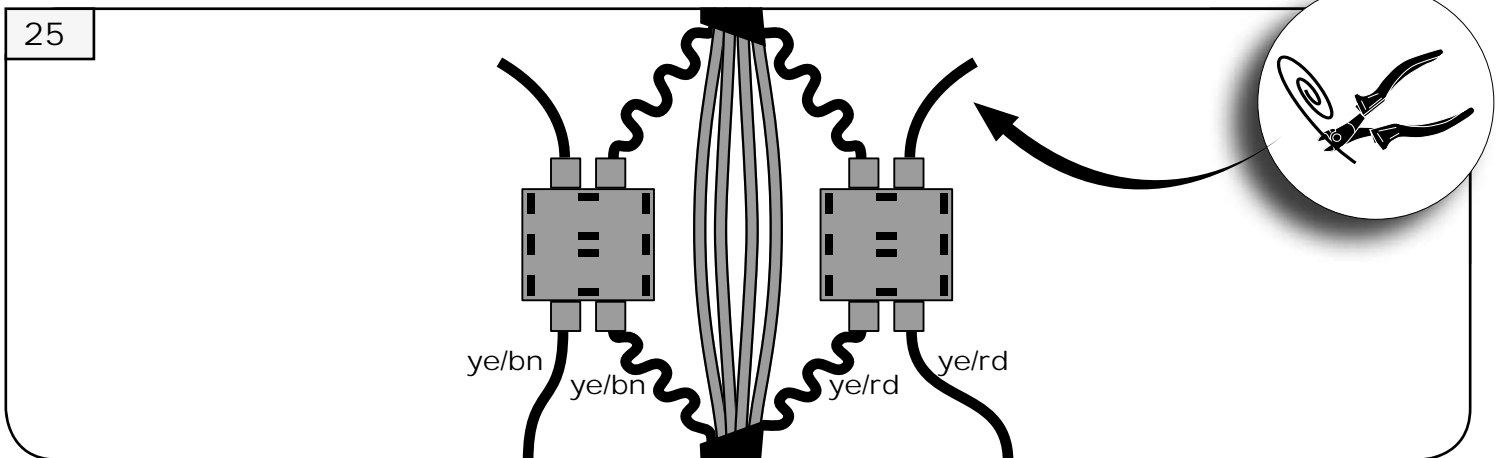

Stecker bu →
connector bu →

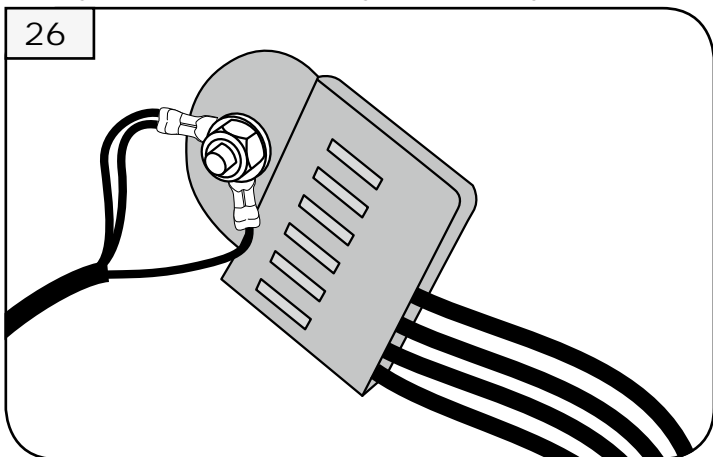

E-Satz ye/bn → kabel ye/bn, E-Satz ye/rd → kabel ye/rd
e-kit ye/bn → cabel car ye/bn, e-kit ye/rd → cabel car ye/rd



E-Satz bn →  , + bn/wh 13 pin
e-kit bn →  , + bn/wh 13 pin

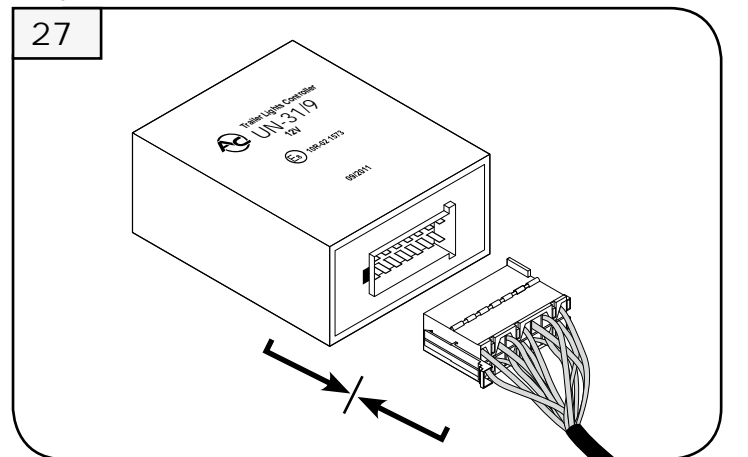

Modul UN-31/9 → Stecker 14 pin E-Satz
modul UN-31/9 → socket 14 pin e-kit

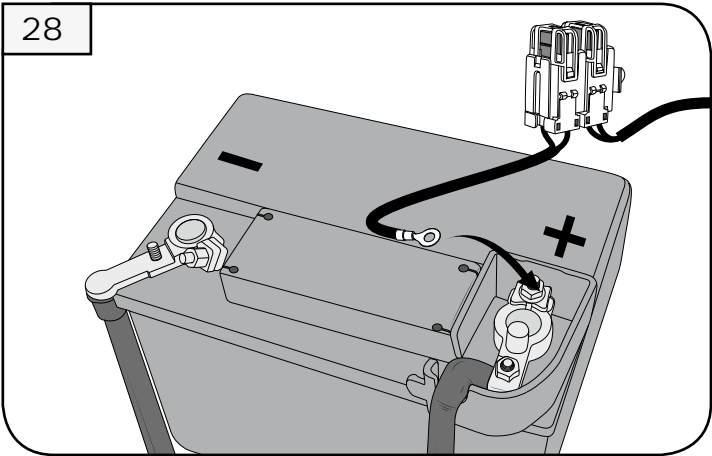

E-Satz rd +30 → + rd/bu 13 pin
 e-kit rd+30 → + rd/bu 13 pin

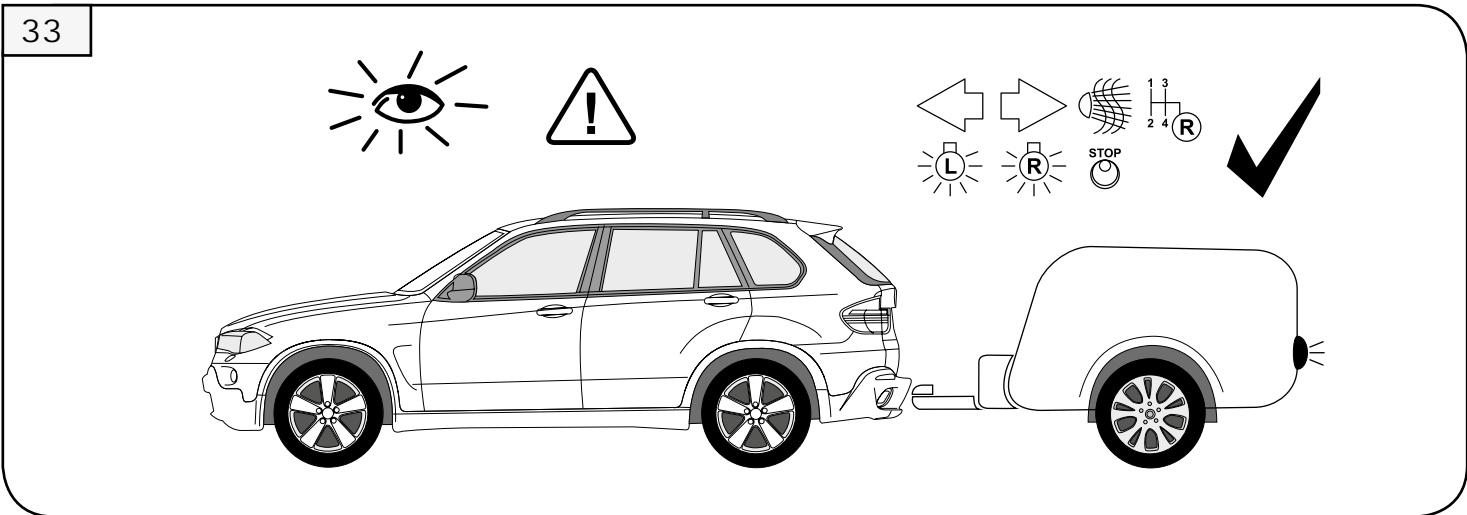
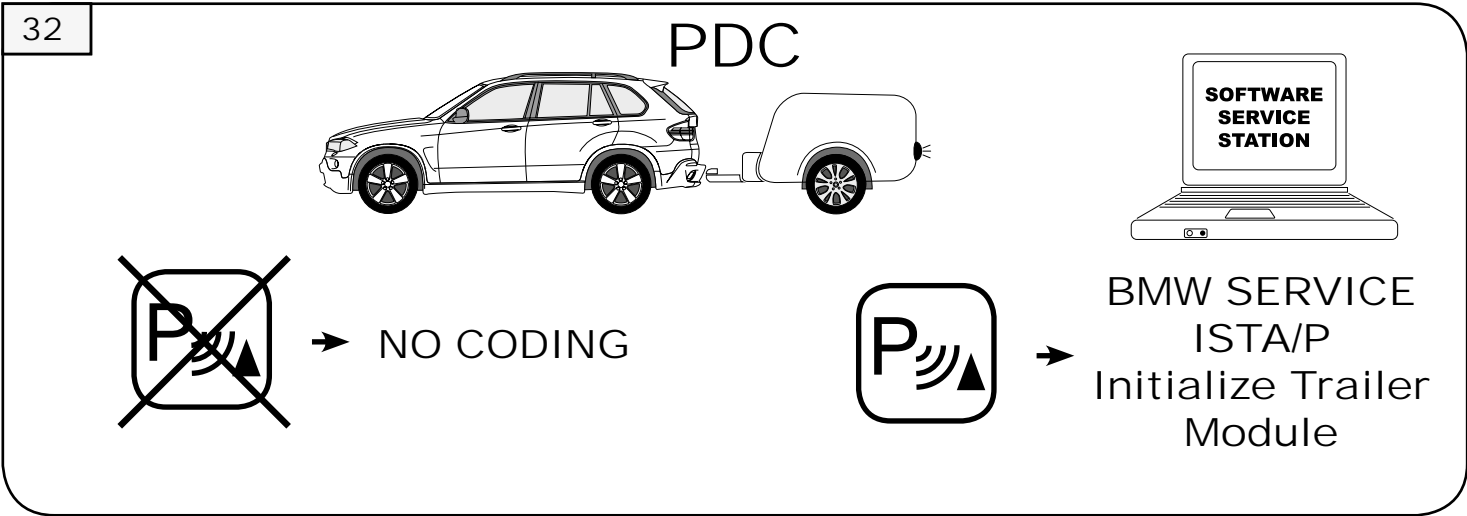
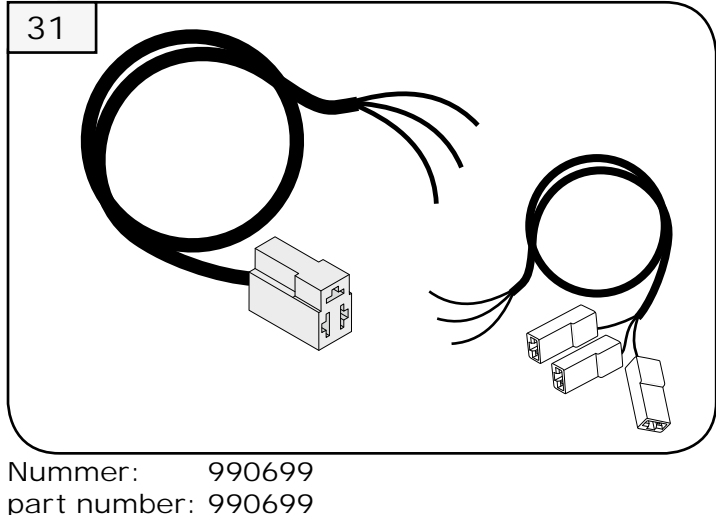
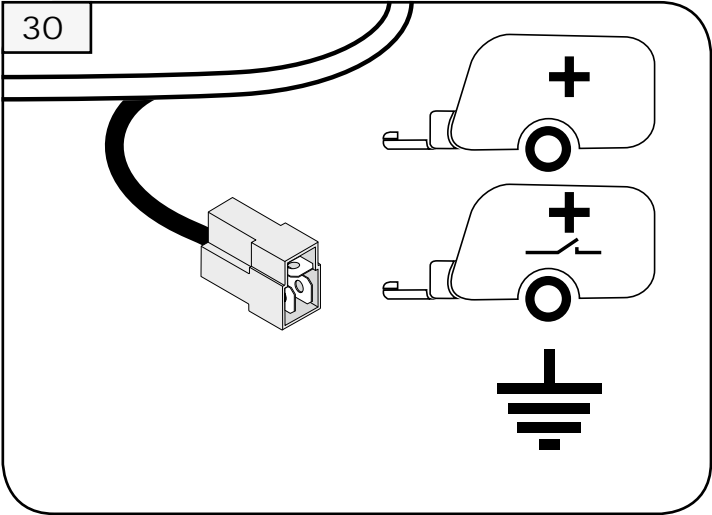
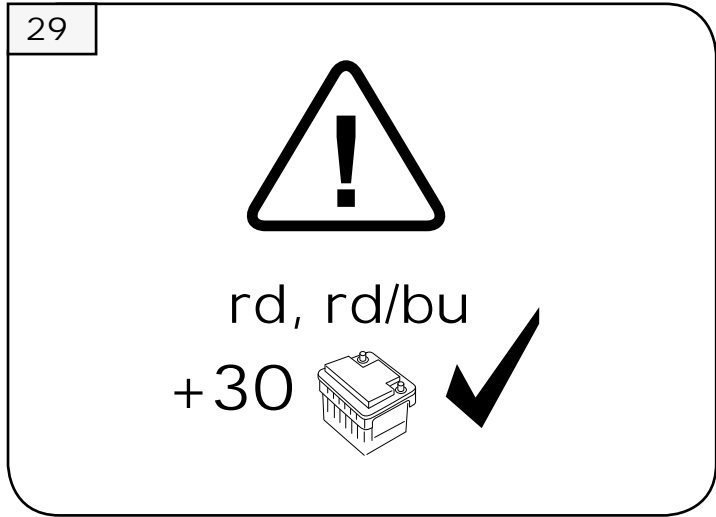

34

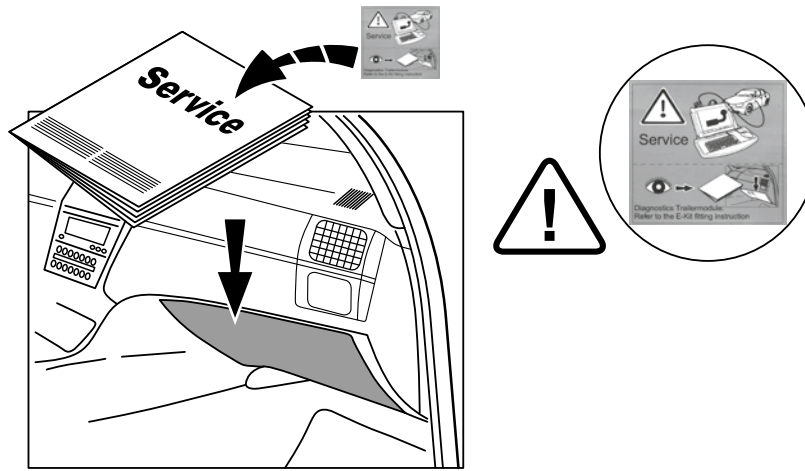

35

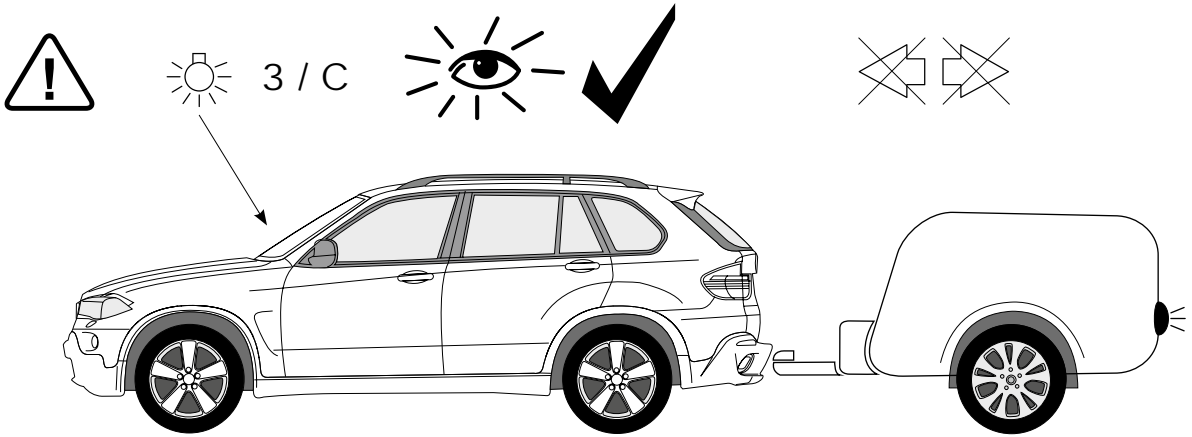

No. 043007-13

BMW X3 (F25) Bj. 03.14 –

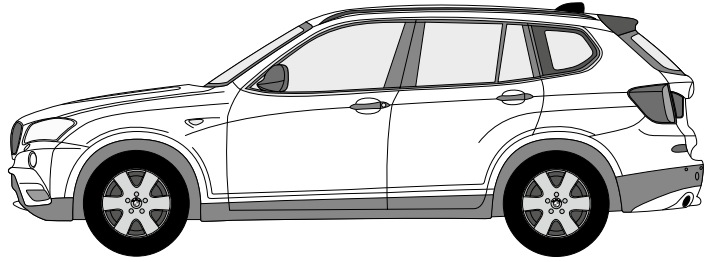

BMW X4 (F26) Bj. 07.14 –

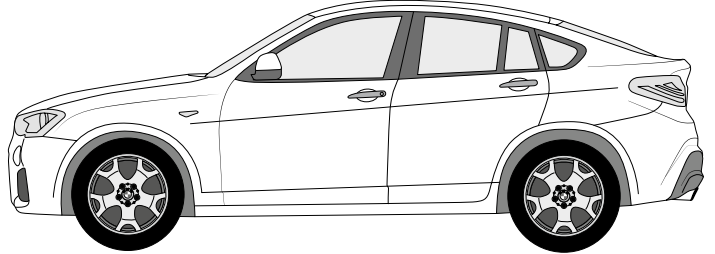

KIT 043007

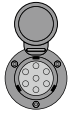

KIT 043013

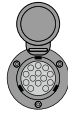

- (D)** Elektrischer Anbausatz für Anhängerkupplung
- (GB)** Electrical Set for Trailer Connection
- (F)** Ensemble électrique pour brancher le crochet d'attelage
- (NL)** Elektrische aansluitset voor trekhaak
- (DK)** Elektrisk tilslutningssæt for trakkrog
- (N)** Elektrisk monteringssett for tilhengerkontakt
- (S)** Elektrisk förbindelsebyggsats av bogseringskrok
- (FIN)** Hinauskoukun sähköliitännäpaketti
- (I)** Kit di congiunzione del gancio per rimorchio
- (E)** Juego de conexión eléctrica de gancho de remolque
- (CZ)** Elektrická připojovací sestava tažného zařízení
- (H)** Elektromos kábelkötég vonóhorog bekötéséhez
- (RU)** Электрический присоединительный комплект буксирного крюка
- (LT)** Elektroninis jungiamasis traukimo kablio rinkinys
- (LV)** Elektroniskais vilkšanas āķa savienojuma komplekts
- (EST)** Elektriline tiisli ühenduskomplekt
- (SK)** Elektroinštalácia pre zapojenie ťažného zariadenia
- (PL)** Elektryczny zestaw przyłączeniowy haka holowniczego

7-pin

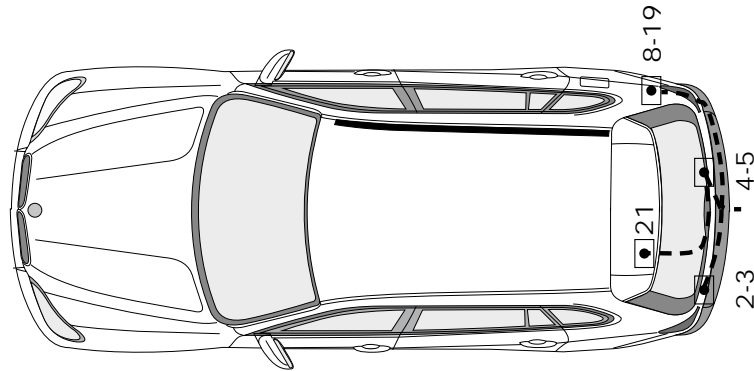
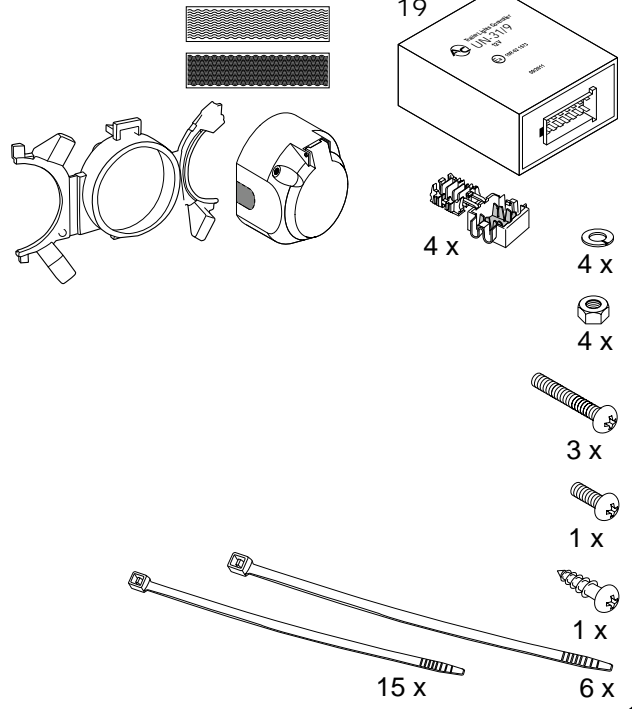
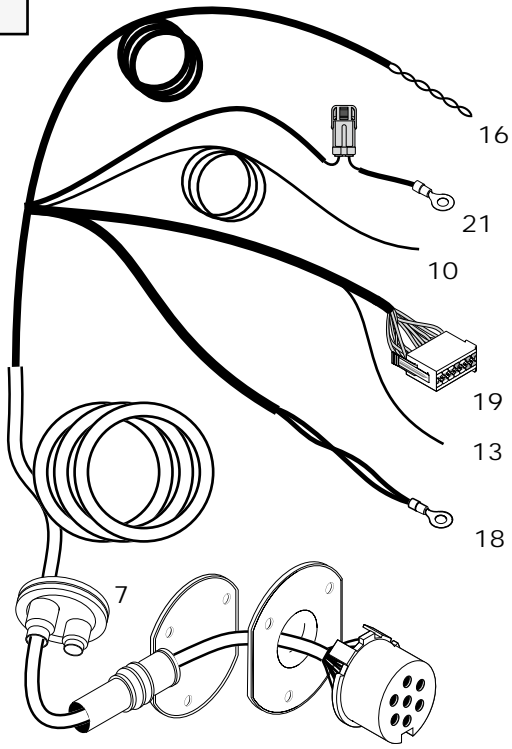

13-pin

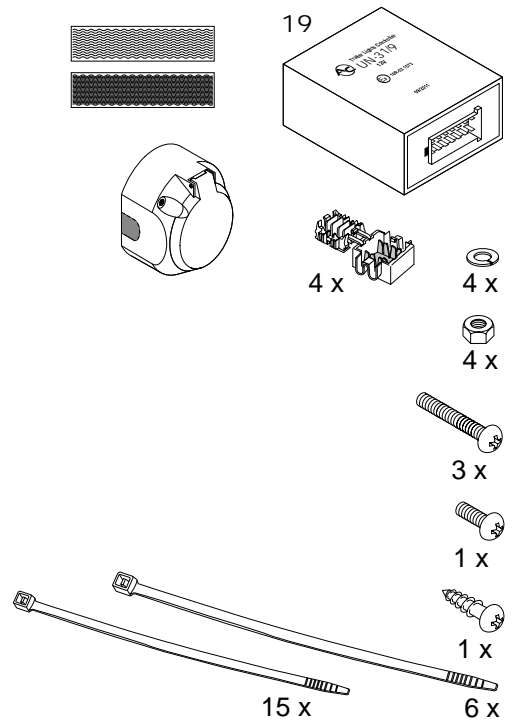
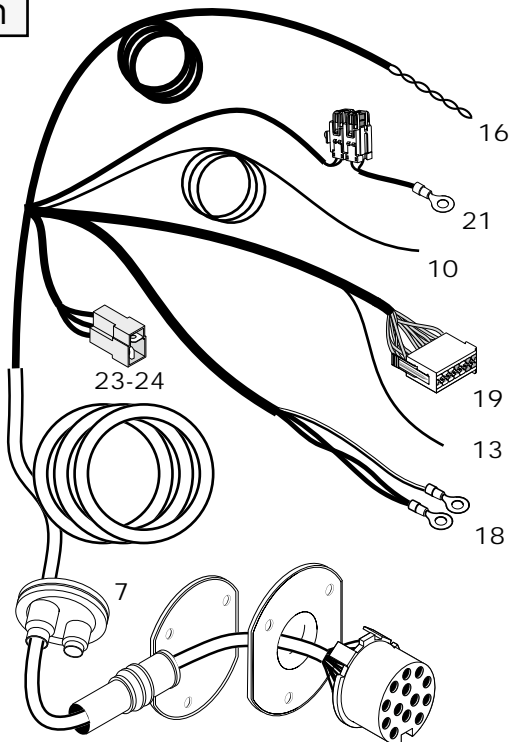

1

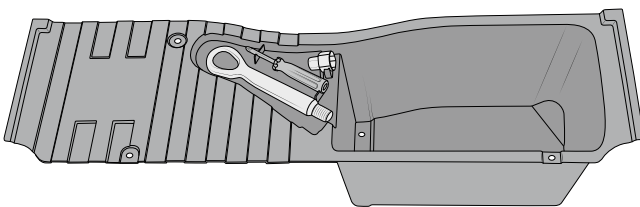
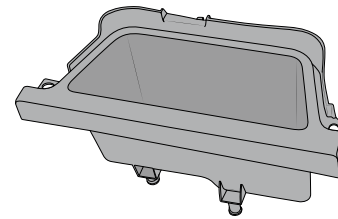
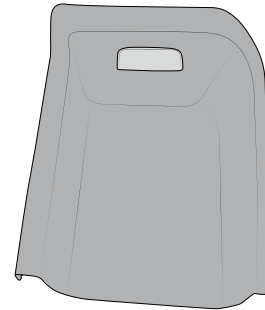
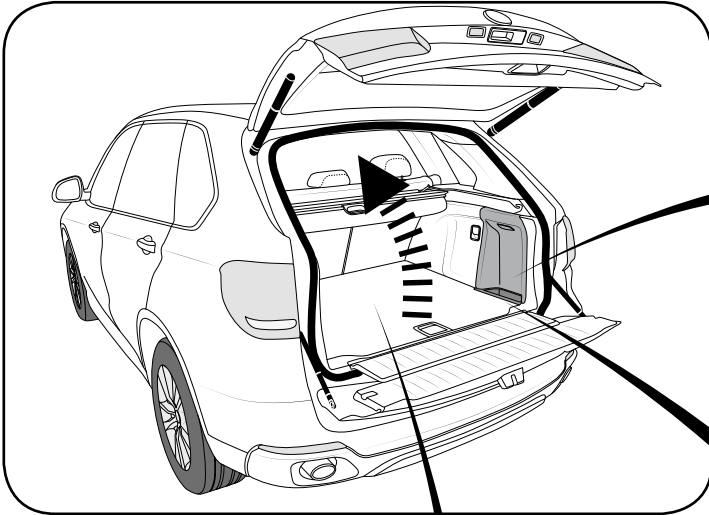
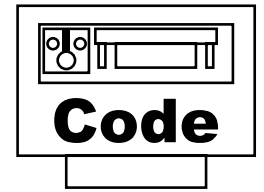
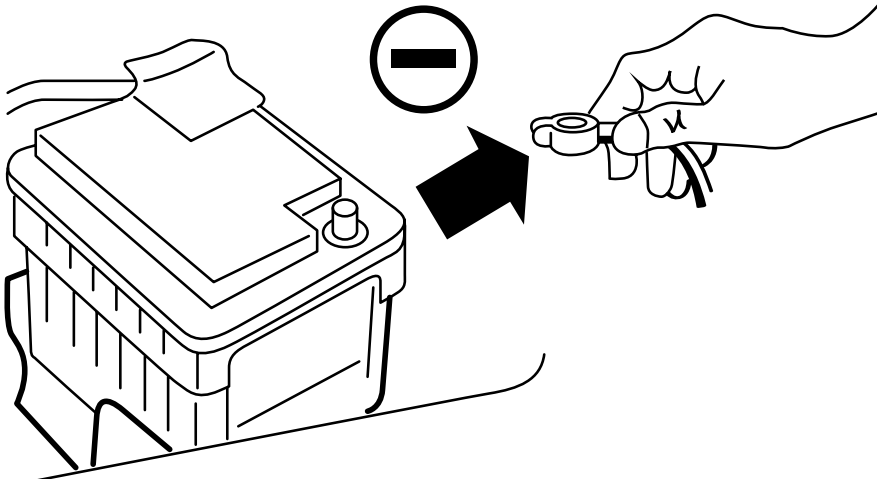

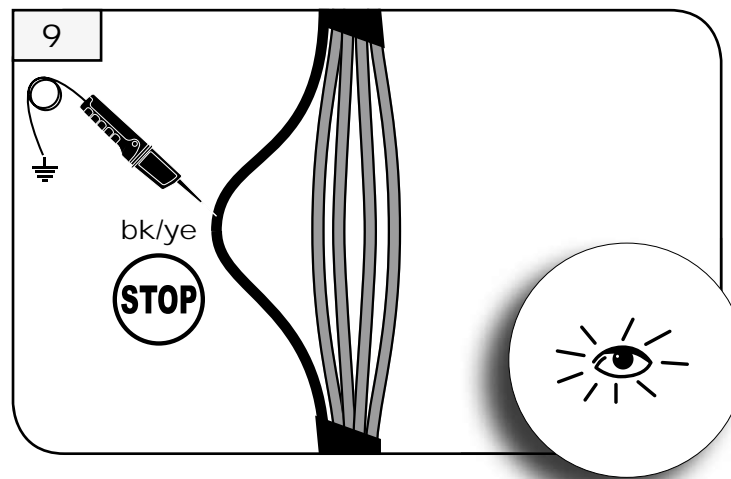
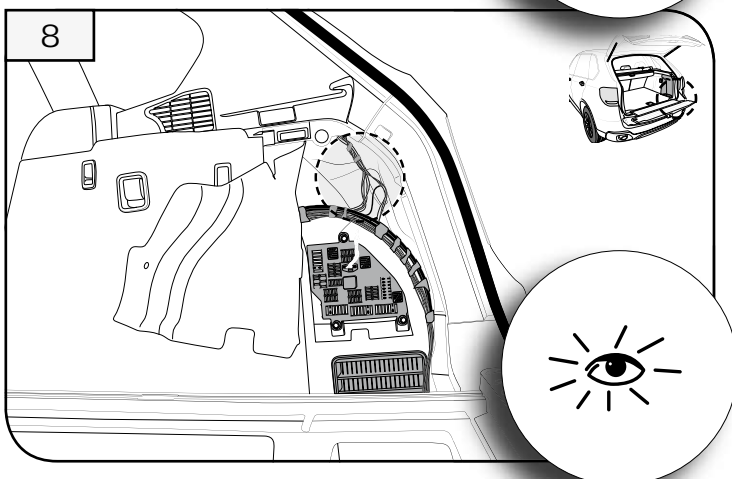
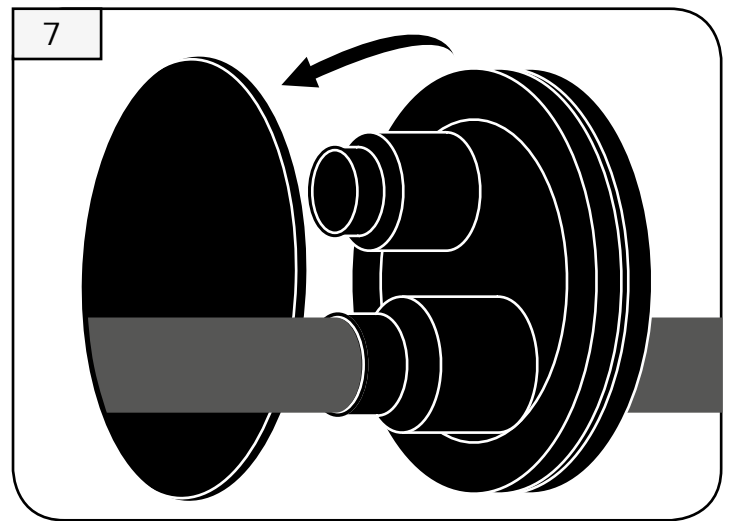
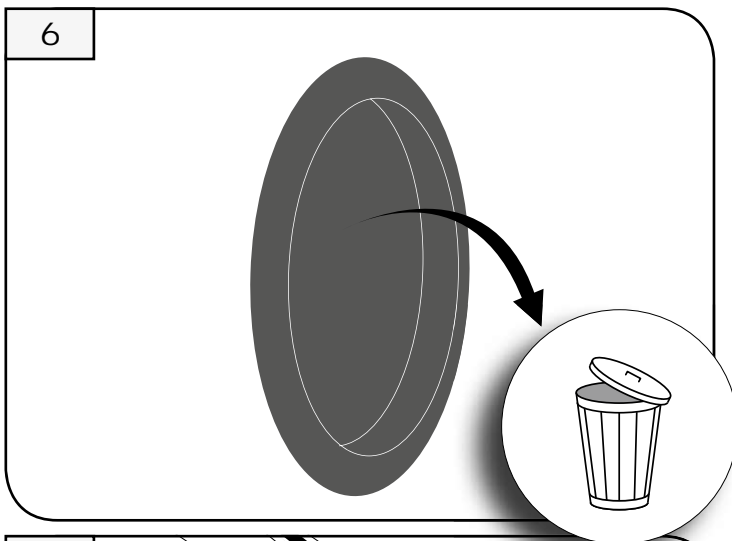
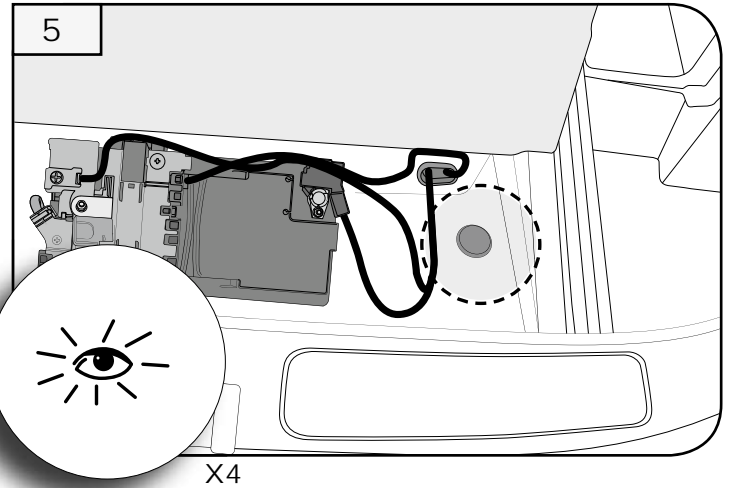
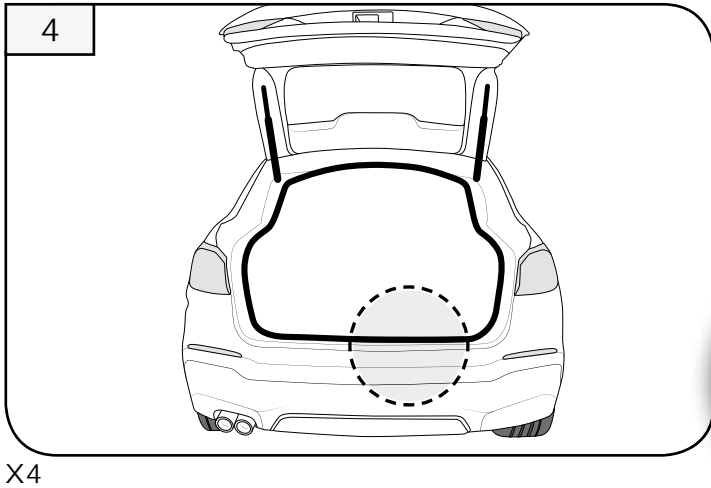
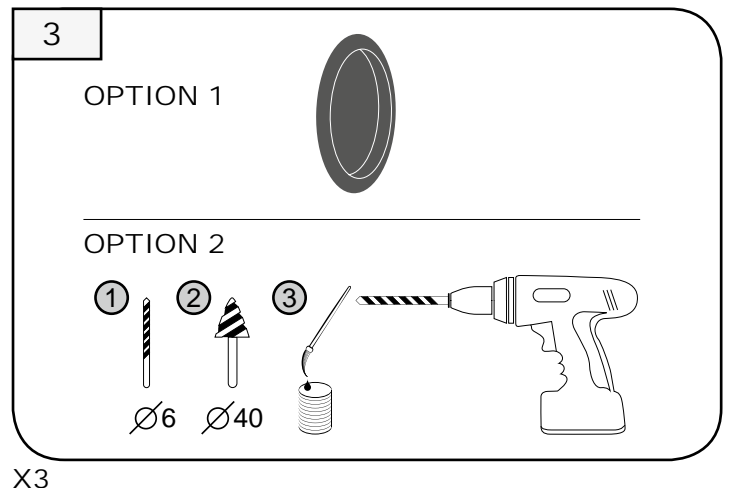
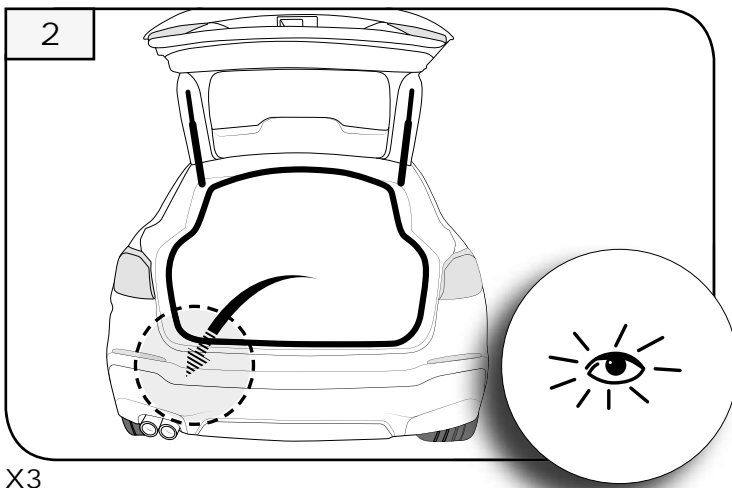

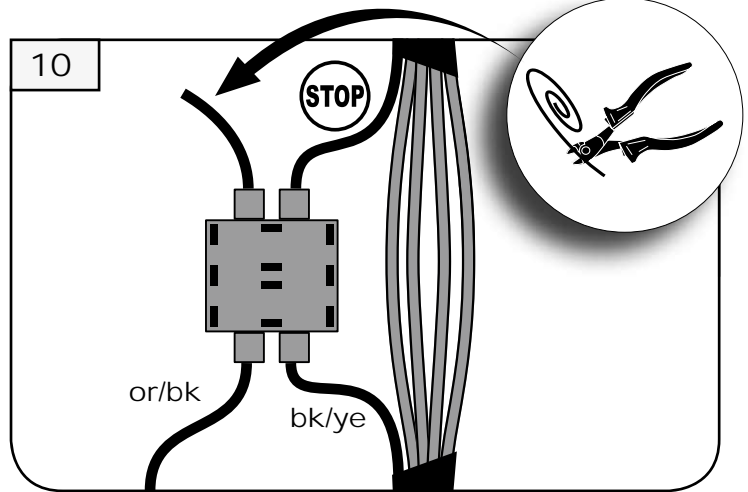
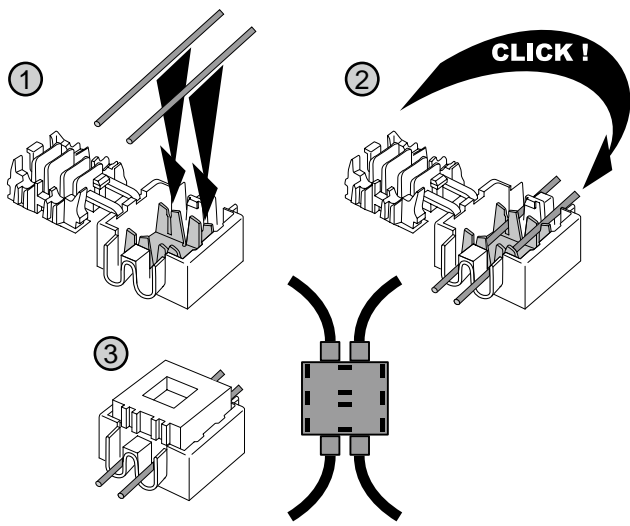

E-Satz or/bk → kabel bk/ye
 e-kit or/bk → cabel car bk/ye **STOP**

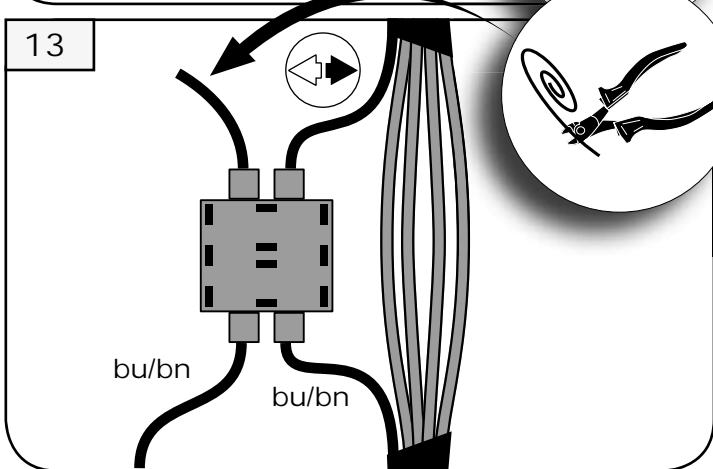
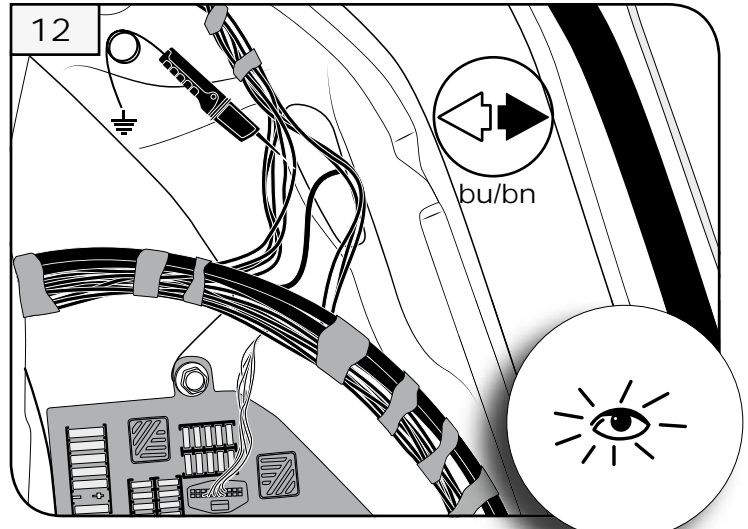
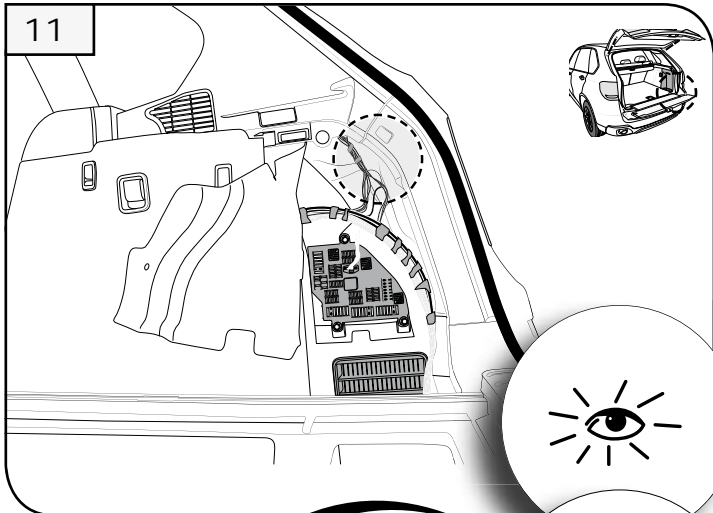

E-Satz bu/bn → kabel bu/bn
 e-kit bu/bn → cabel car bu/bn

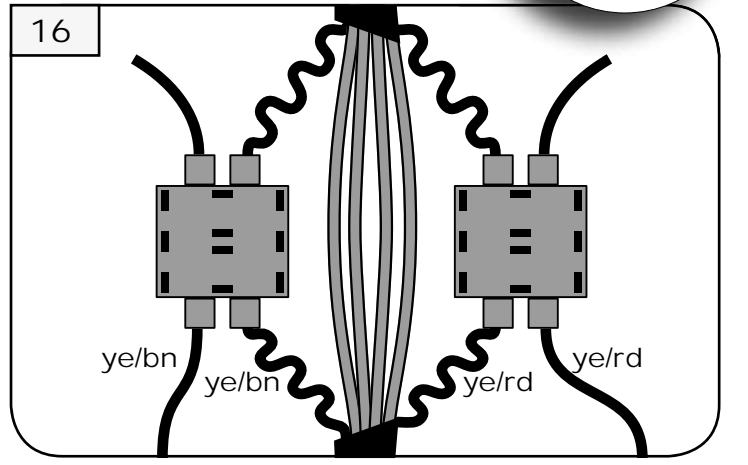
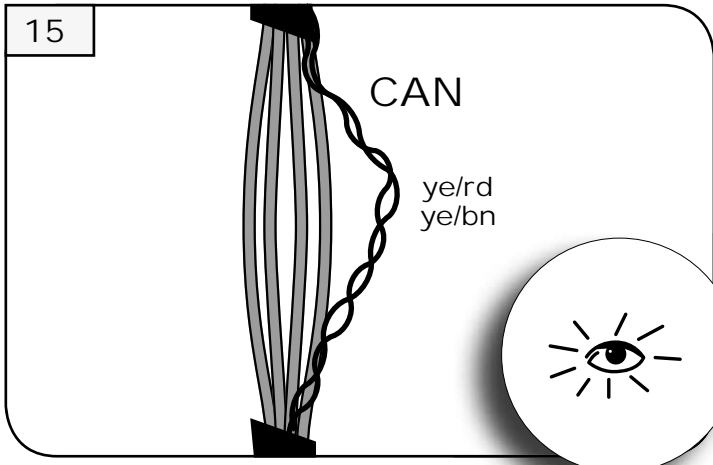
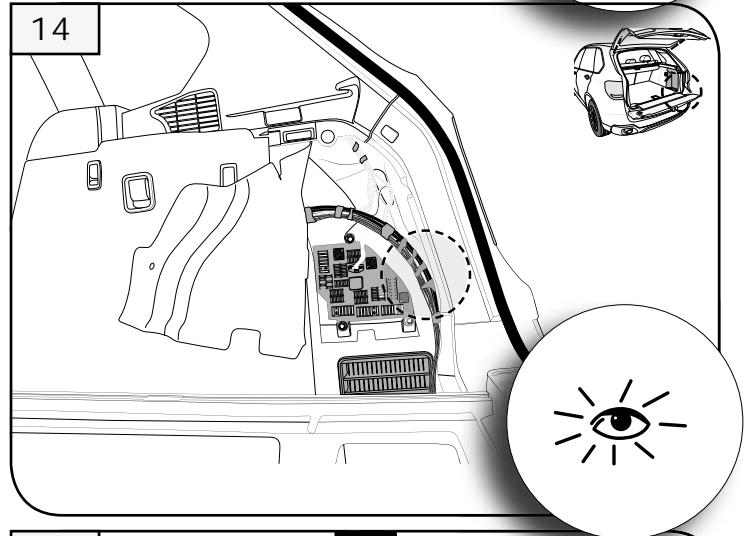

E-Satz ye/bn → kabel ye/bn, E-Satz ye/rd → kabel ye/rd
 e-kit ye/bn → cabel car ye/bn, e-kit ye/rd → cabel car ye/rd

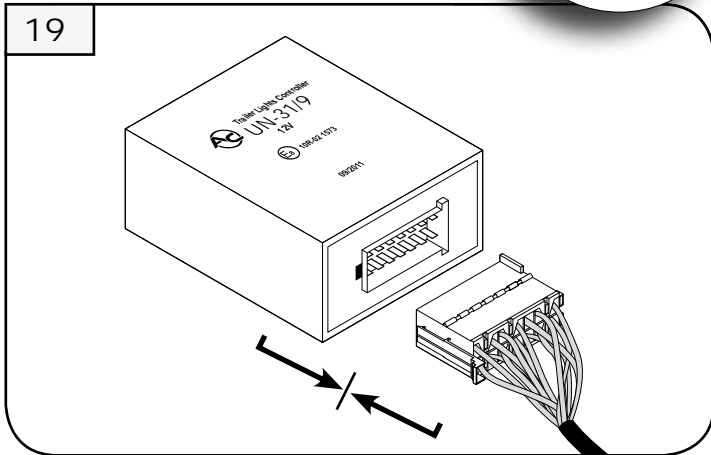
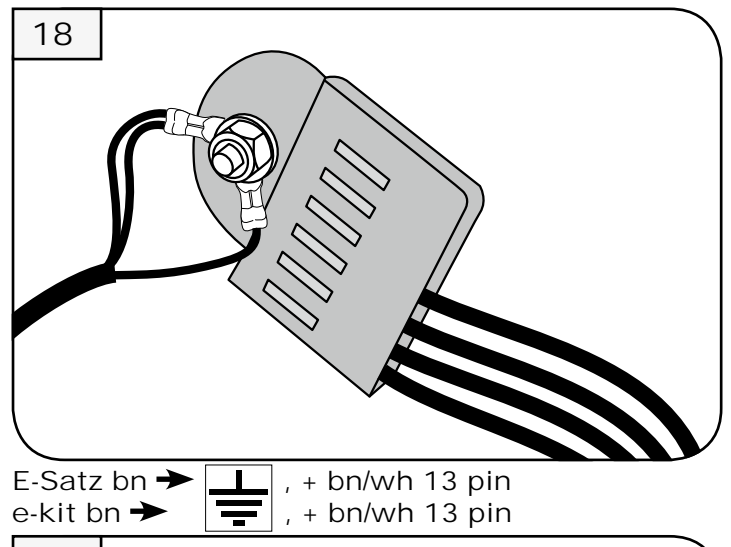
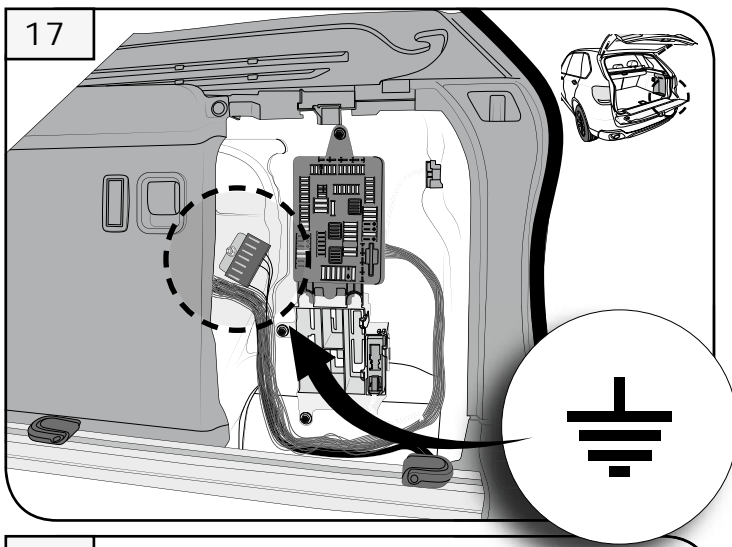

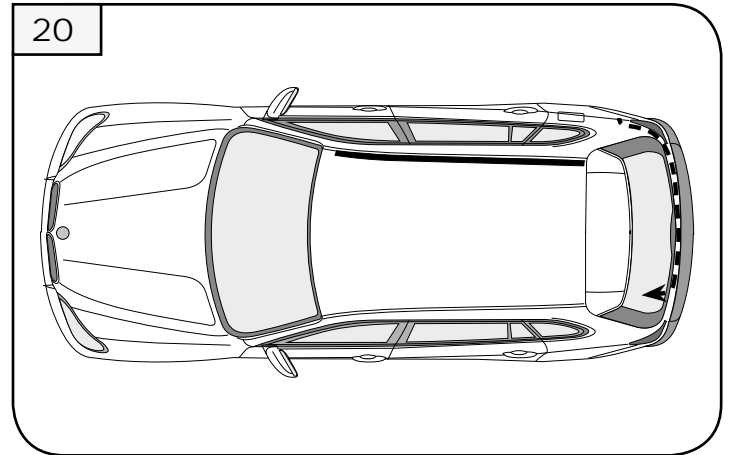

Modul UN-31/9 → Stecker 14 pin E-Satz
 modul UN-31/9 → socket 14 pin e-kit

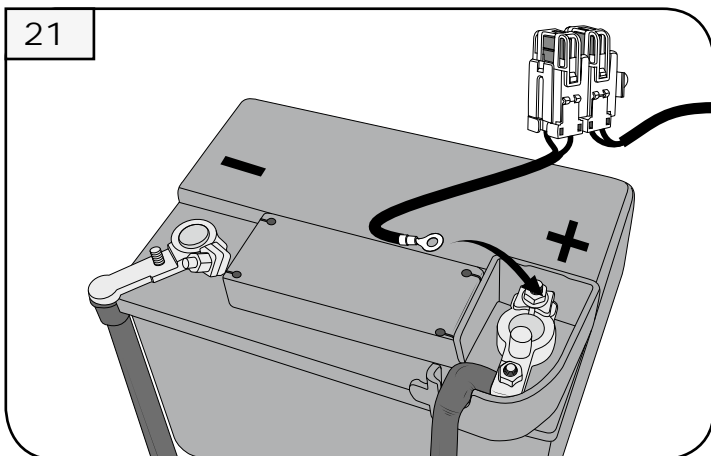

E-Satz rd + rd/bu 13 pin
 e-kit rd + rd/bu 13 pin



E-Satz rd +30 →  + rd/bu 13 pin
 e-kit rd+30 →  + rd/bu 13 pin

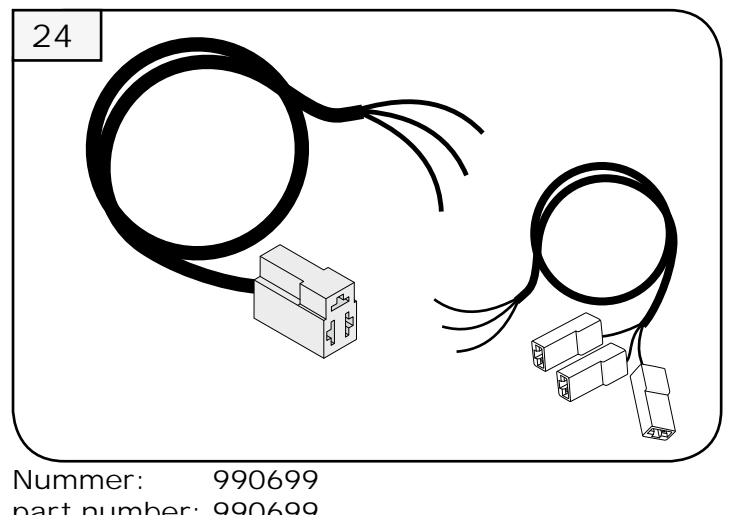
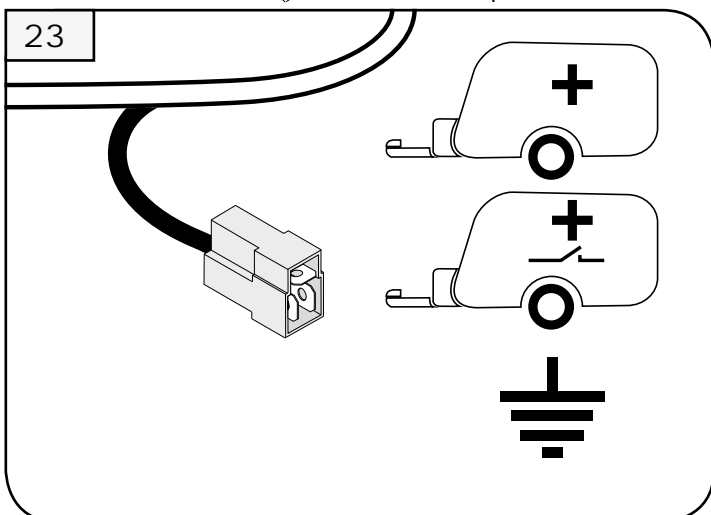
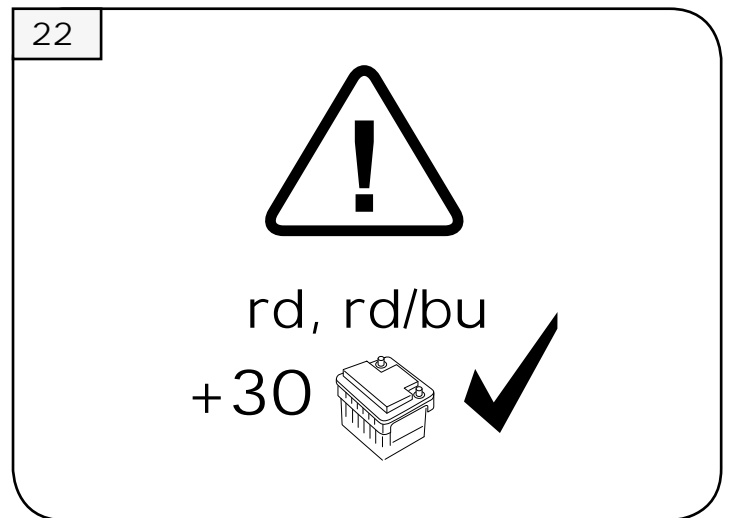

25

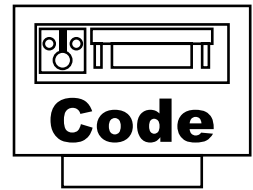
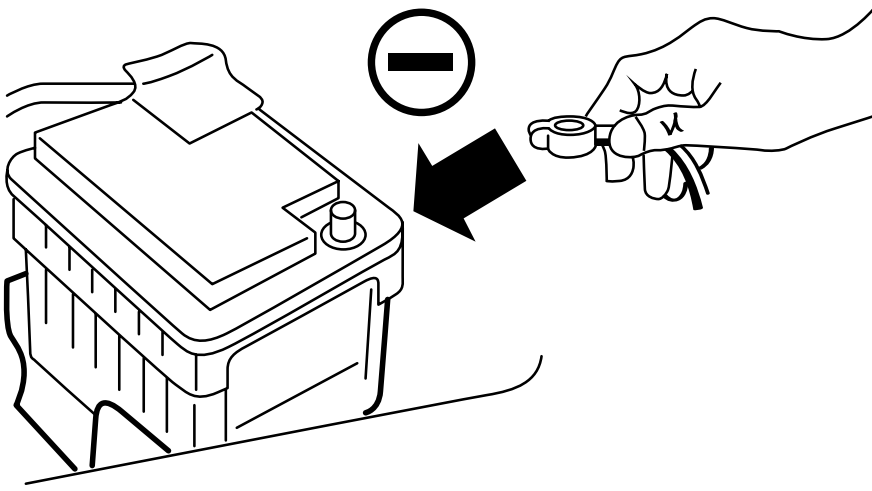

26

PDC



➔ NO CODING



➔ BMW SERVICE
ISTA/P
Initialize Trailer
Module

27

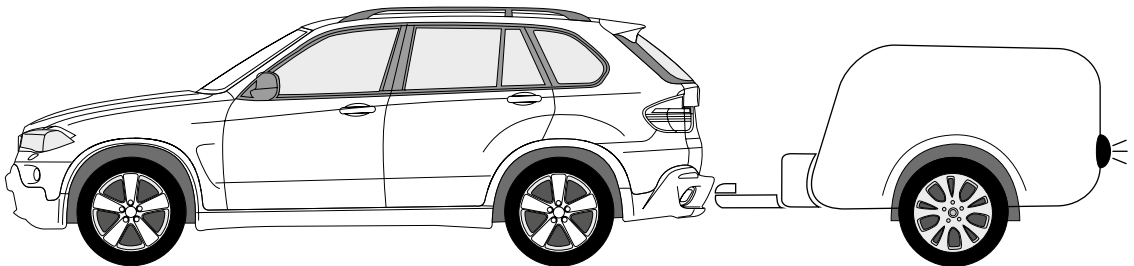
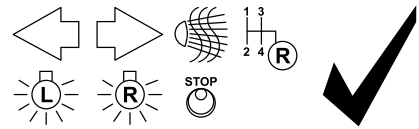

28

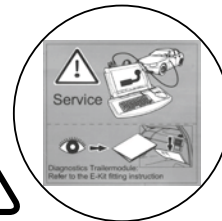
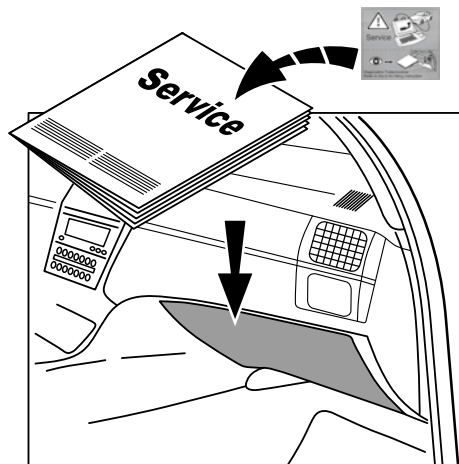



3 / C

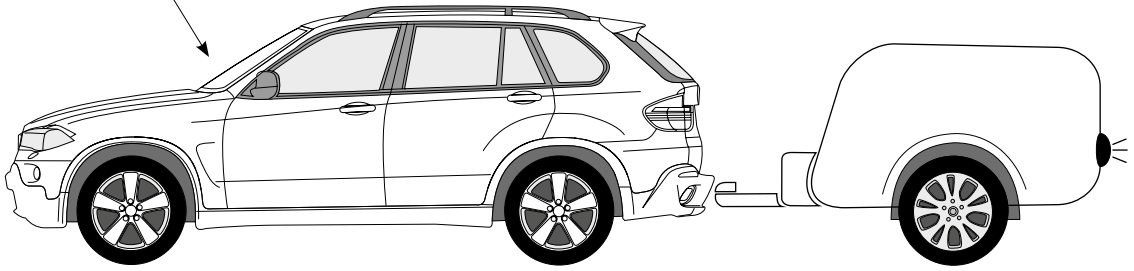
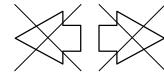
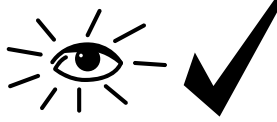

No. 043007-13

BMW X5 (F15) Bj. 11.2013 –
BMW X6 (F16) Bj. 12.2014 –

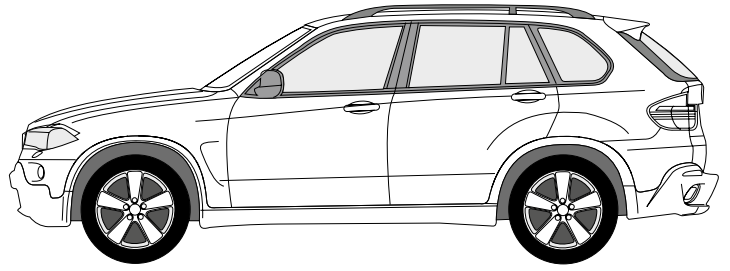

KIT 043007

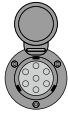

KIT 043013



- (D)** Elektrischer Anbausatz für Anhängerkupplung
- (GB)** Electrical Set for Trailer Connection
- (F)** Ensemble électrique pour brancher le crochet d'attelage
- (NL)** Elektrische aansluitset voor trekhaak
- (DK)** Elektrisk tilslutningssæt for trakkrog
- (N)** Elektrisk monteringssett for tilhengerkontakt
- (S)** Elektrisk förbindelsebyggsats av bogseringskrok
- (FIN)** Hinauskoukun sähköliitännäpaketti
- (I)** Kit di congiunzione del gancio per rimorchio
- (E)** Juego de conexión eléctrica de gancho de remolque
- (CZ)** Elektrická připojovací sestava tažného zařízení
- (H)** Elektromos kábelköteg vonóhorog bekötéséhez
- (RU)** Электрический присоединительный комплект буксирного крюка
- (LT)** Elektroninis jungiamasis traukimo kablio rinkinys
- (LV)** Elektroniskais vilkšanas āķa savienojuma komplekts
- (EST)** Elektriline tiisli ühenduskomplekt
- (SK)** Elektroinštalácia pre zapojenie ťažného zariadenia
- (PL)** Elektryczny zestaw przyłączeniowy haka holowniczego

7-pin

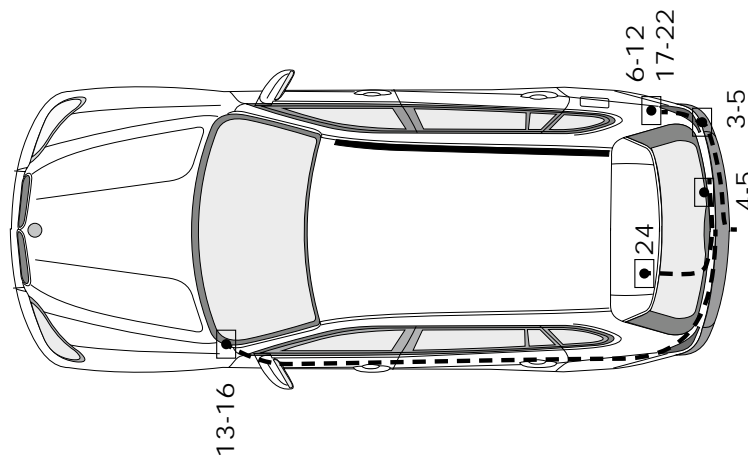
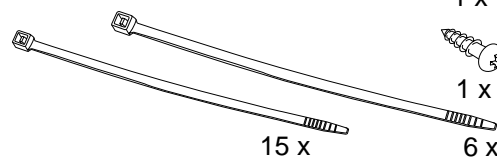
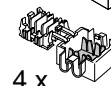
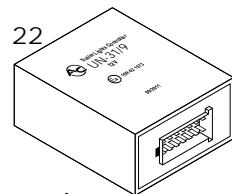
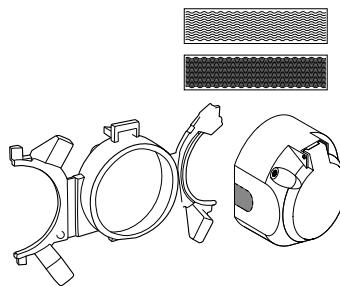
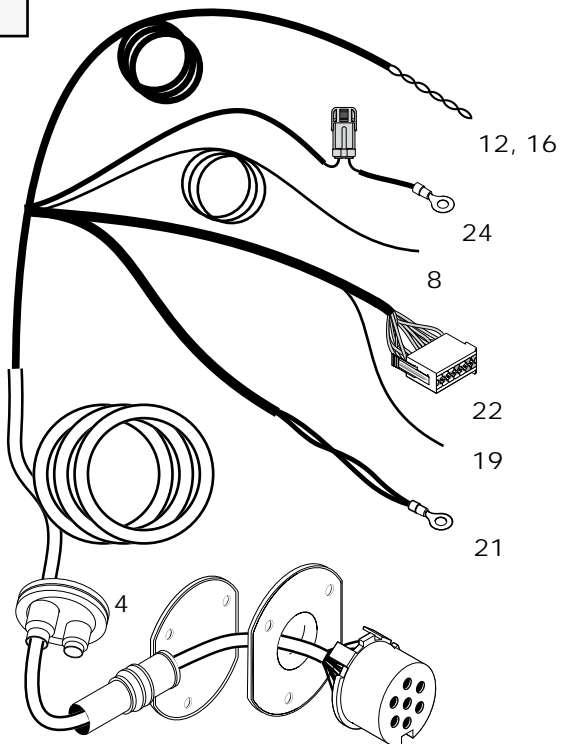

13-pin

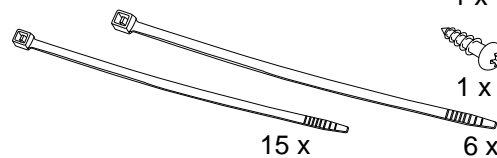
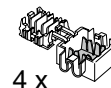
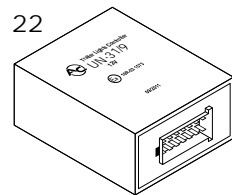
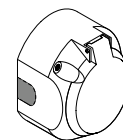
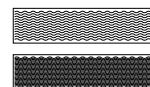
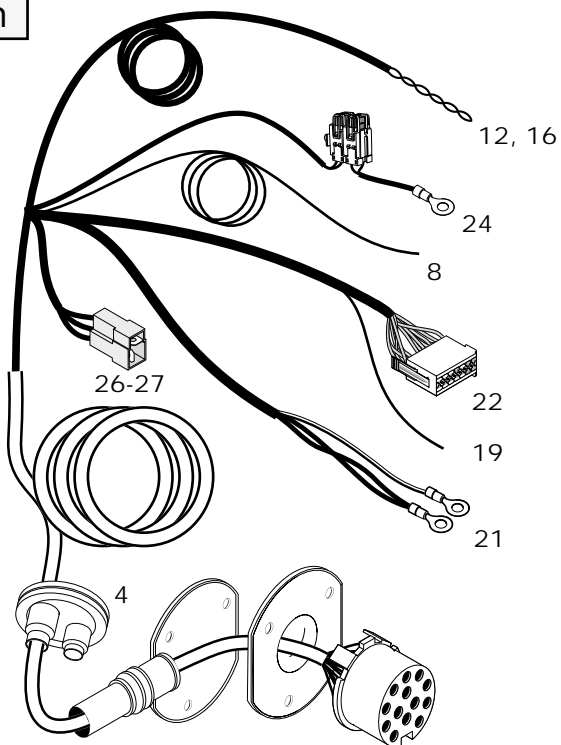

1

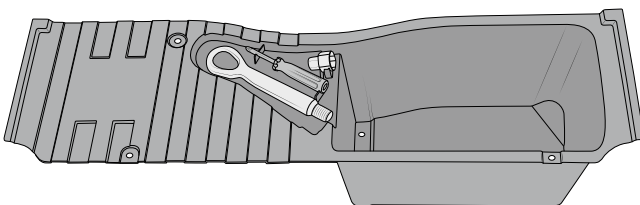
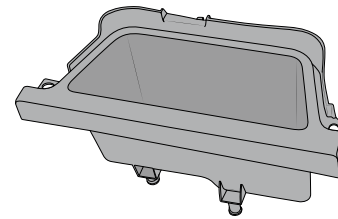
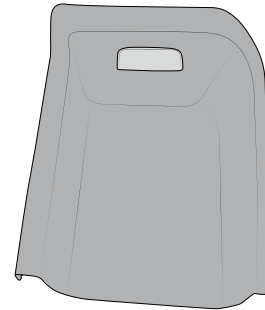
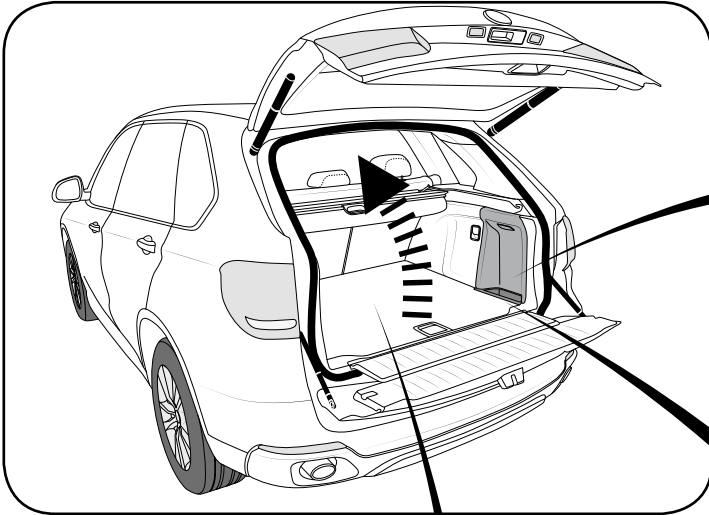
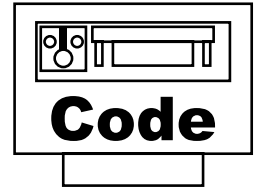
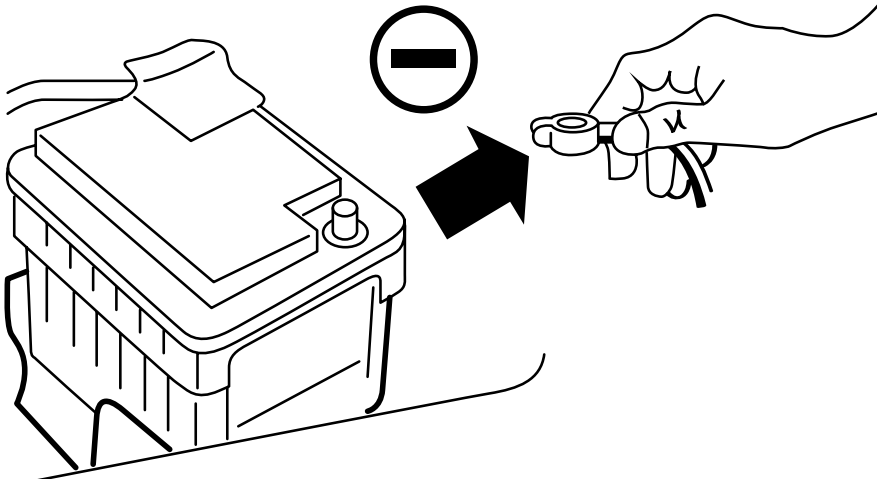

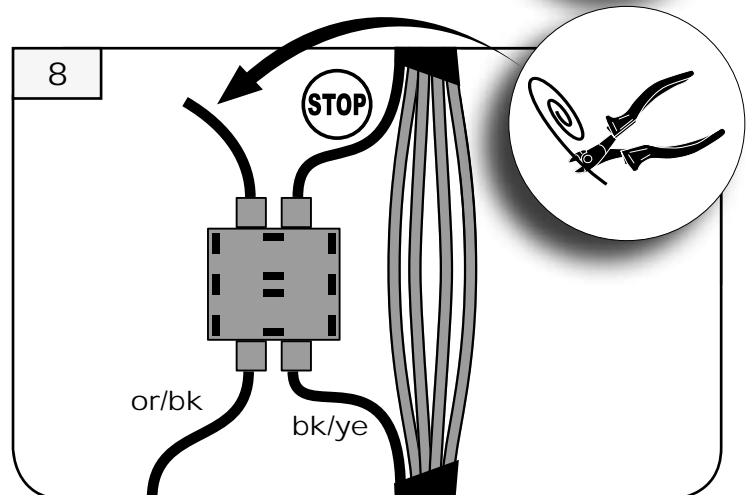
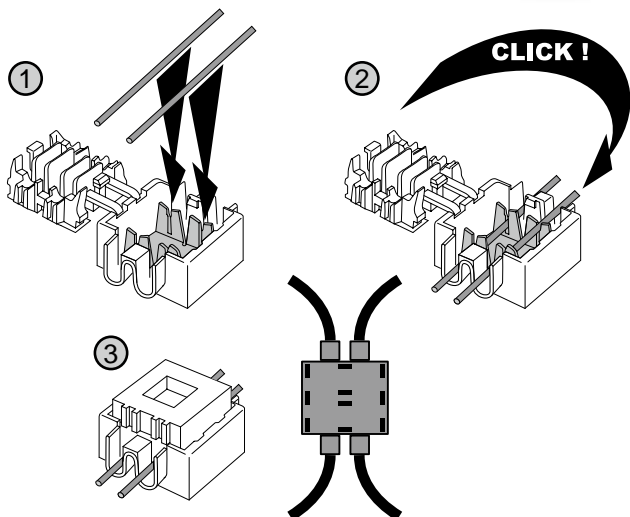
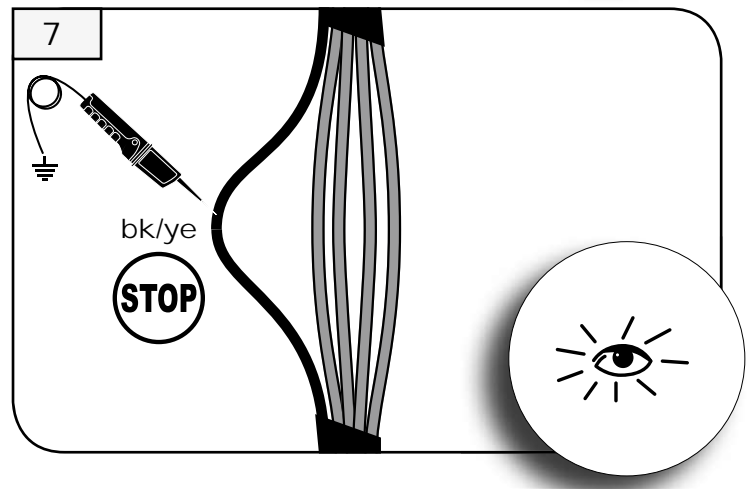
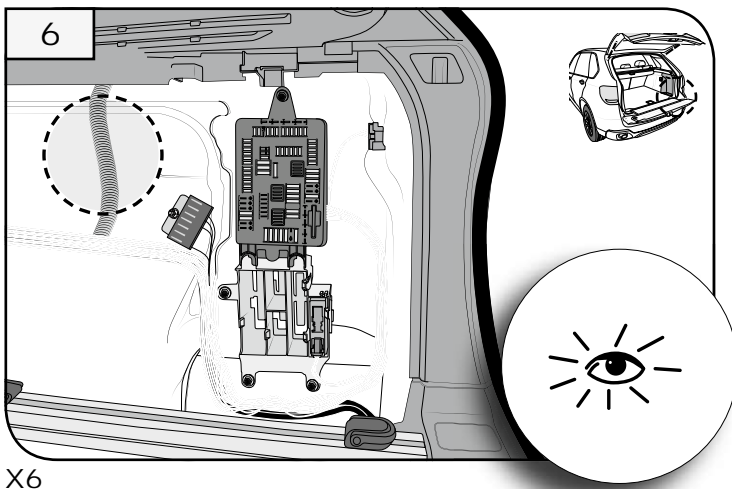
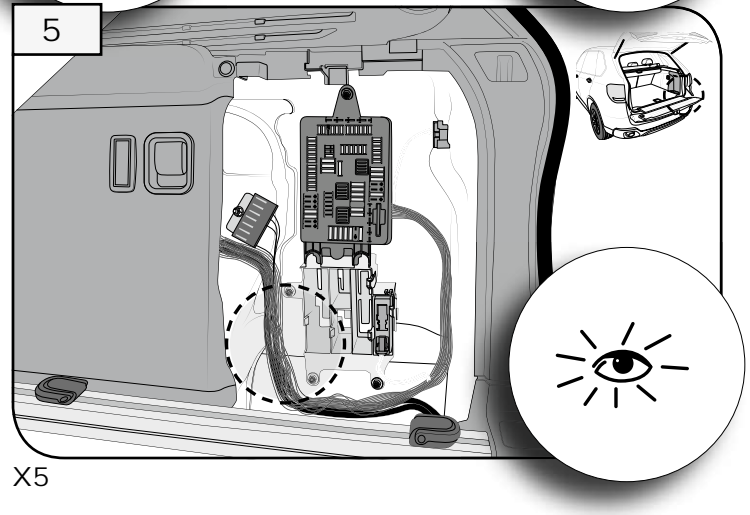
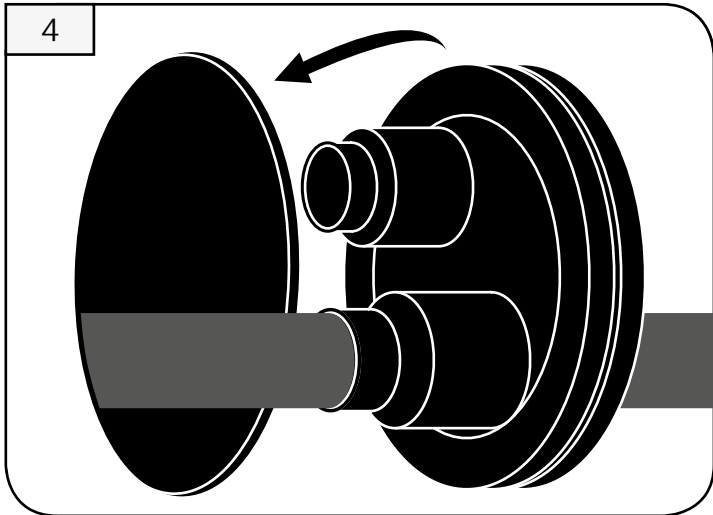
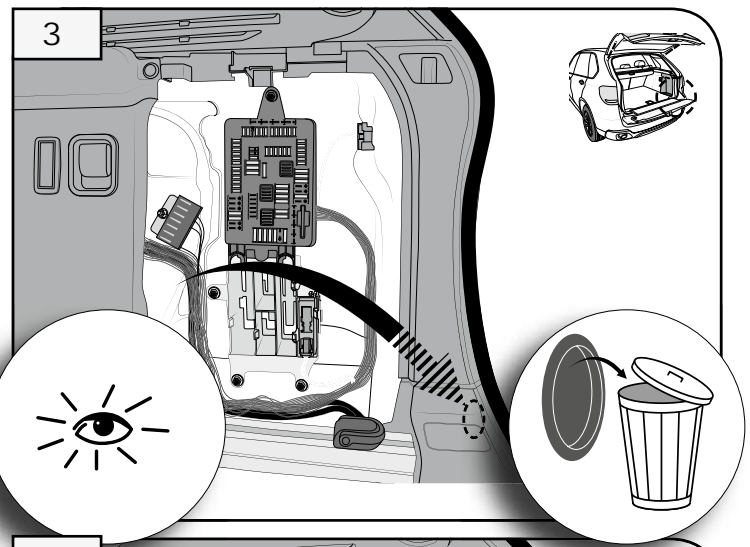
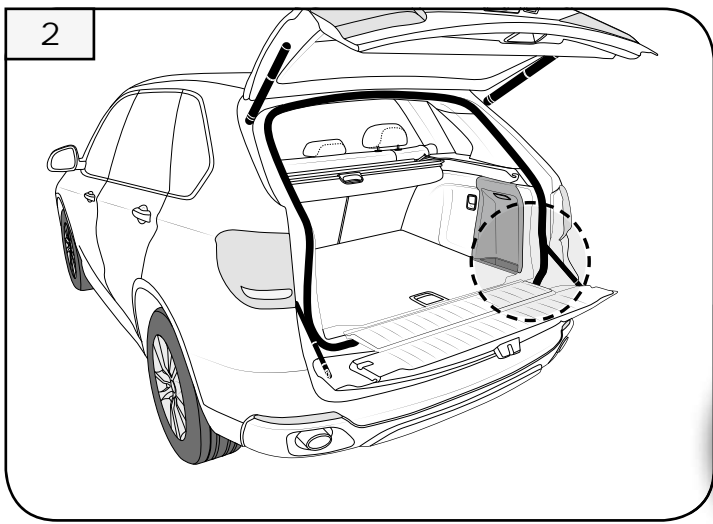

E-Satz or/bk → kabel bk/ye
 e-kit or/bk → cabel car bk/ye

STOP

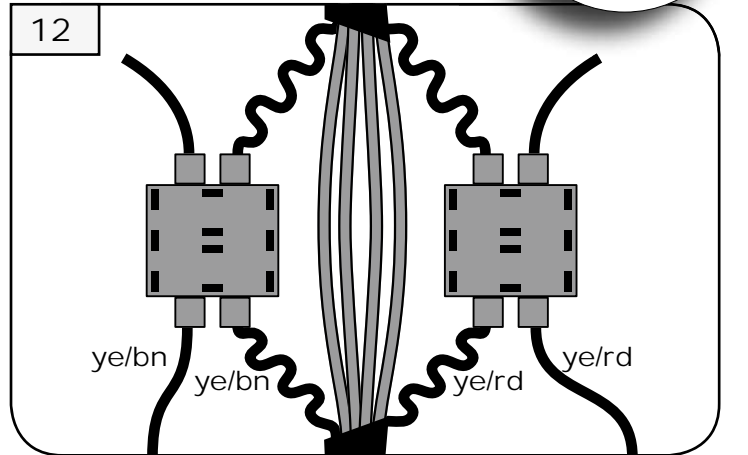
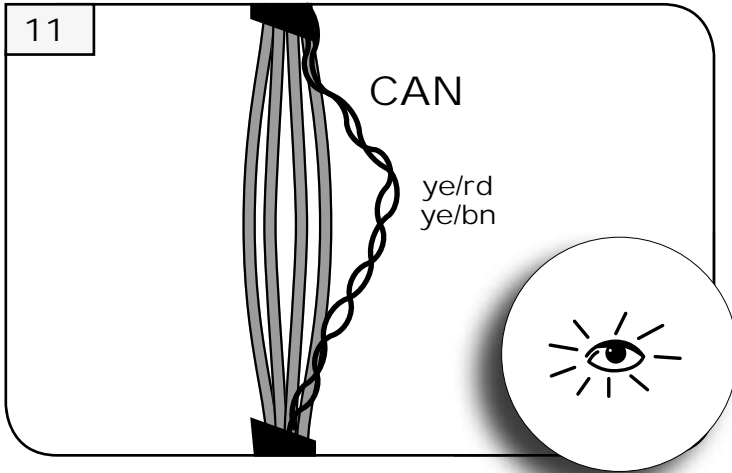
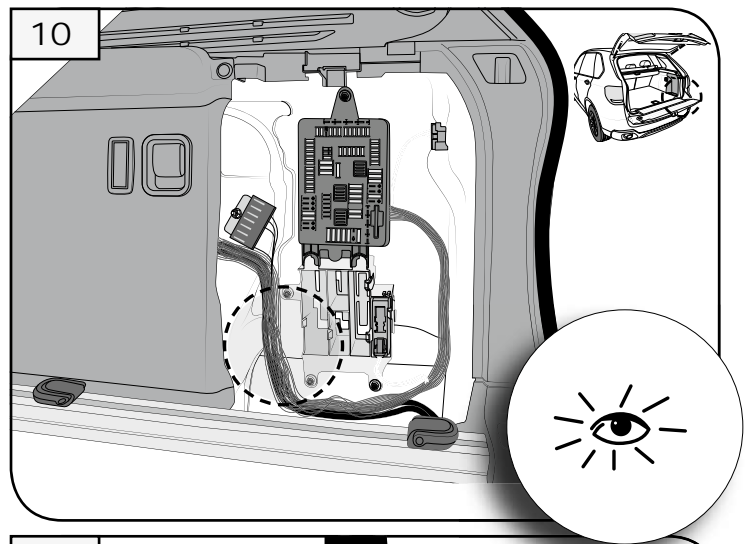
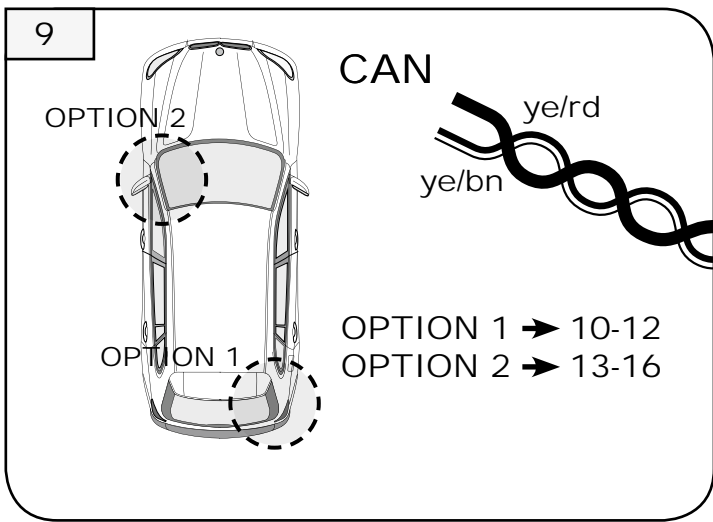

E-Satz ye/bn → kabel ye/bn, E-Satz ye/rd → kabel ye/rd
 e-kit ye/bn → cabel car ye/bn, e-kit ye/rd → cabel car ye/rd

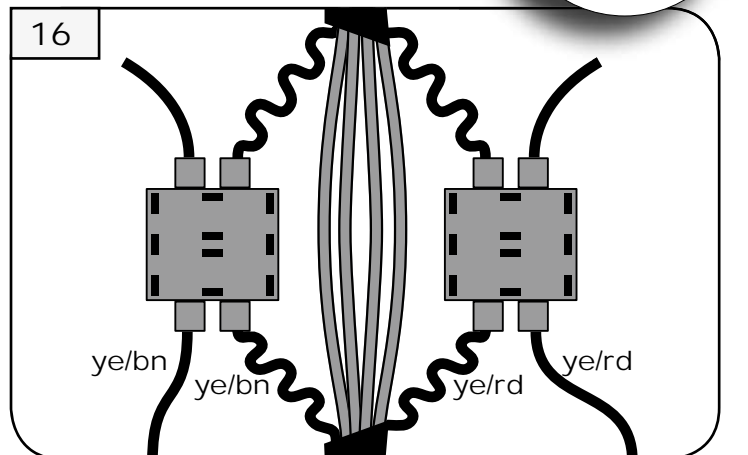
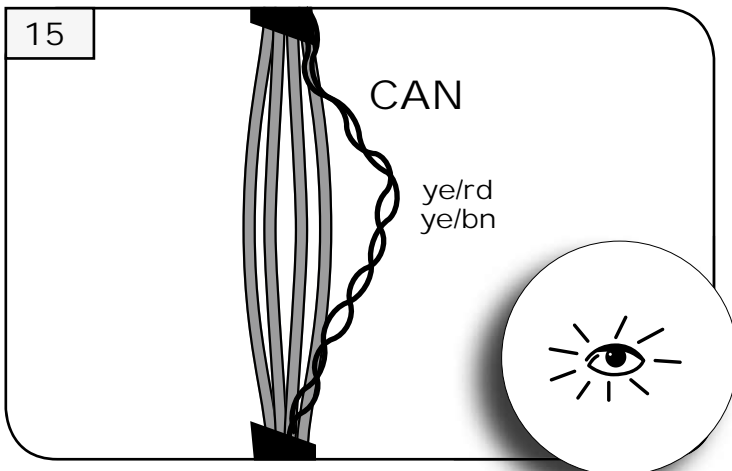
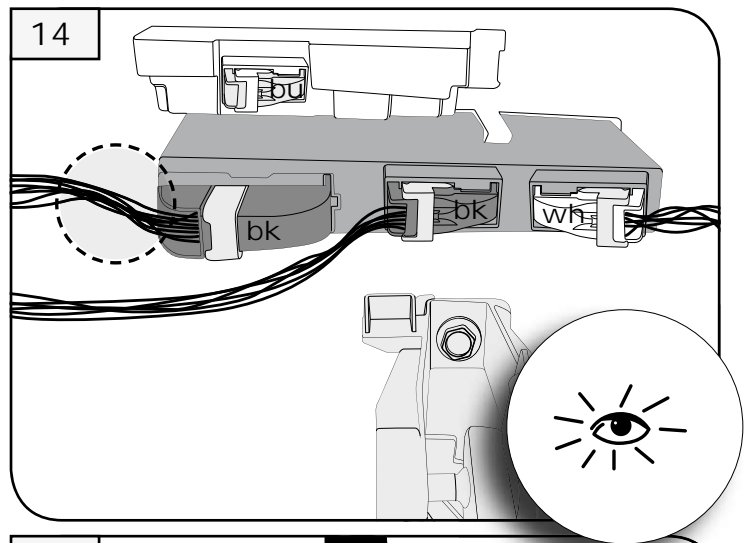
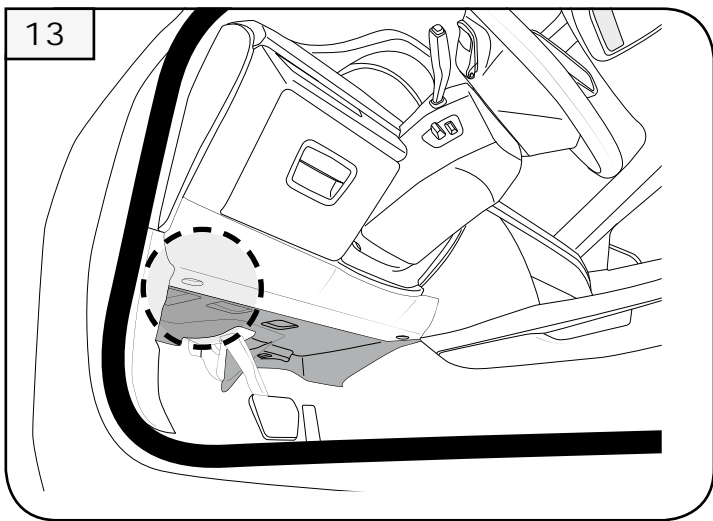

E-Satz ye/bn → kabel ye/bn, E-Satz ye/rd → kabel ye/rd
 e-kit ye/bn → cabel car ye/bn, e-kit ye/rd → cabel car ye/rd

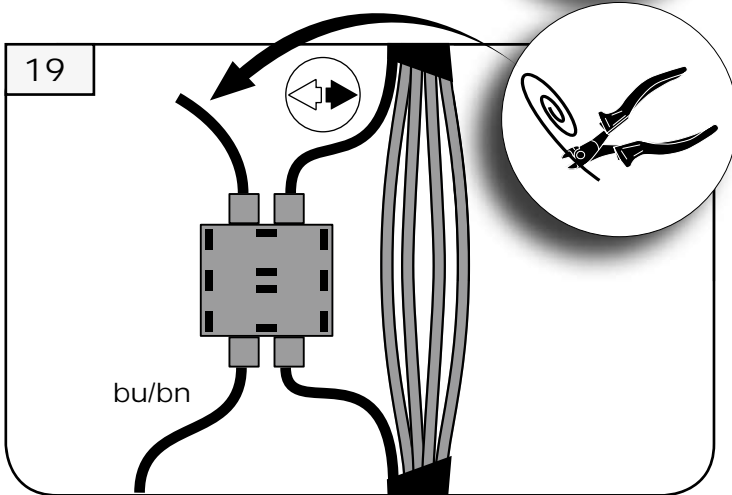
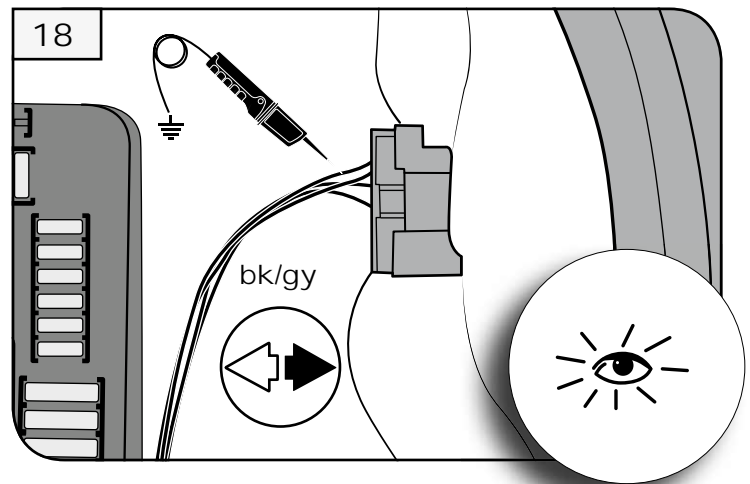
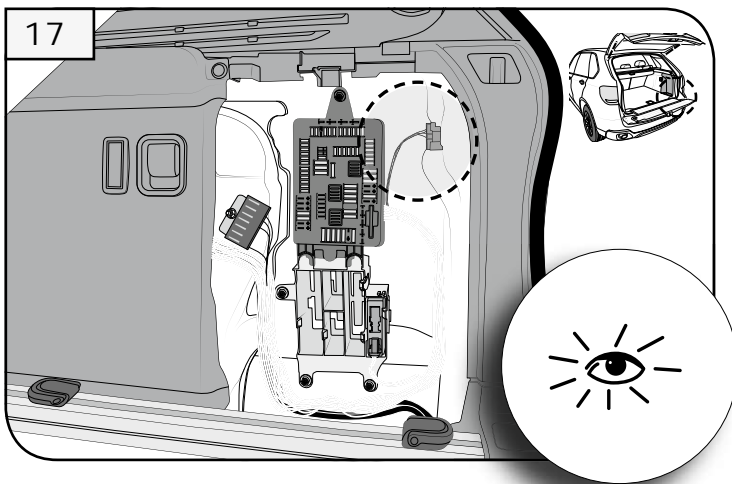

E-Satz bu/bn → kabel
 e-kit bu/bn → cabel car

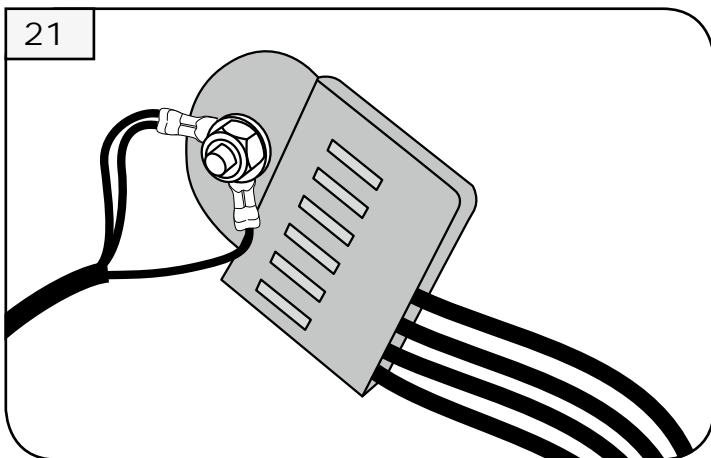
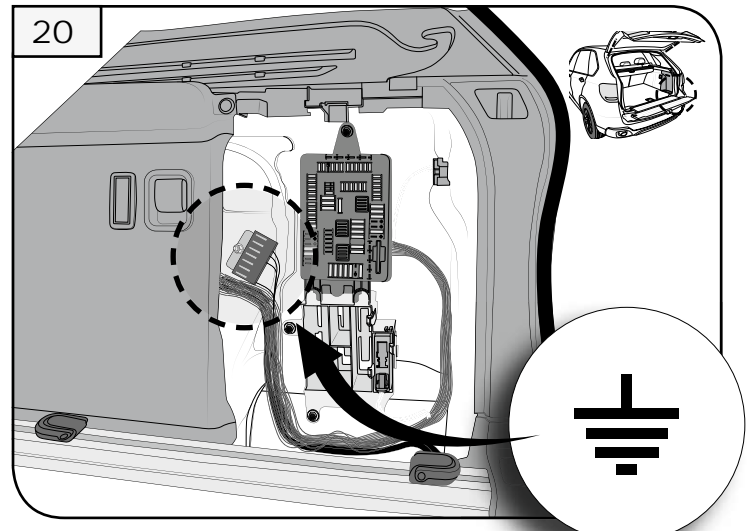

E-Satz bn →  , + bn/wh 13 pin
 e-kit bn →  , + bn/wh 13 pin

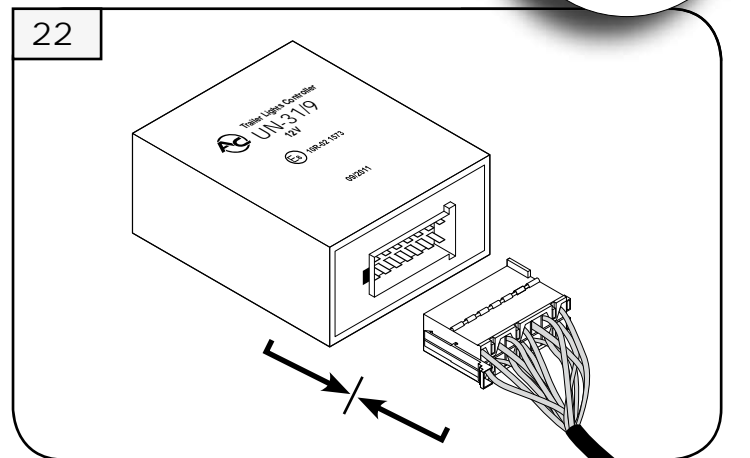

Modul UN-31/9 → Stecker 14 pin E-Satz
 modul UN-31/9 → socket 14 pin e-kit

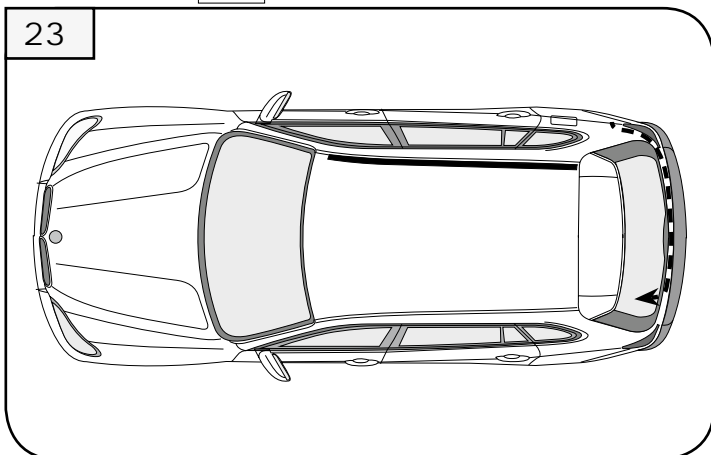

E-Satz rd + rd/bu 13 pin
 e-kit rd + rd/bu 13 pin

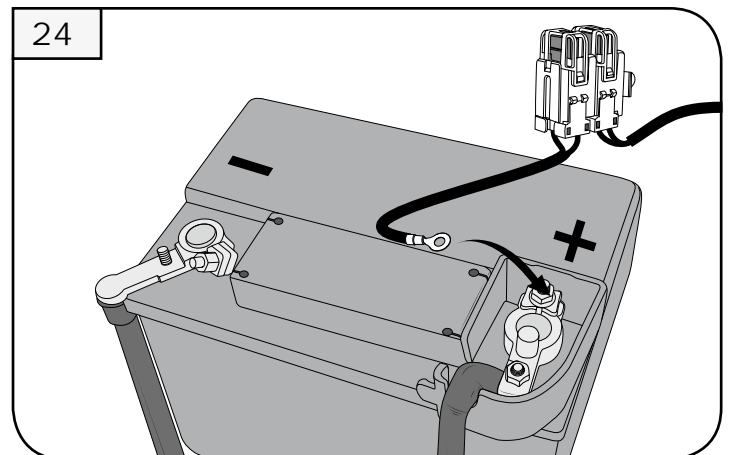

E-Satz rd +30 →  + rd/bu 13 pin
 e-kit rd+30 →  + rd/bu 13 pin

25

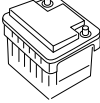

rd, rd/bu
+30  ✓

26

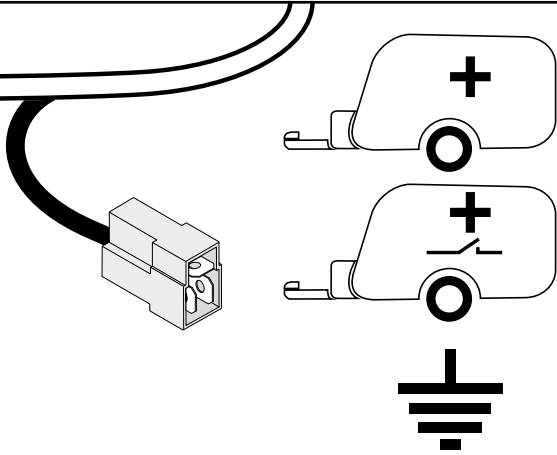

27

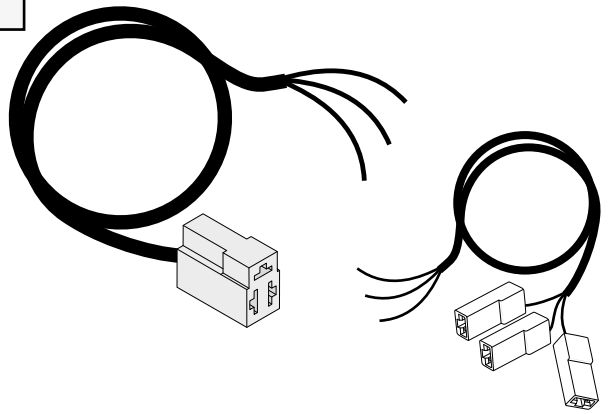

Nummer: 990699
part number: 990699

28

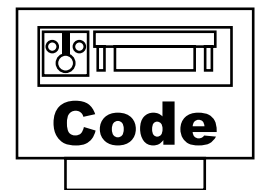
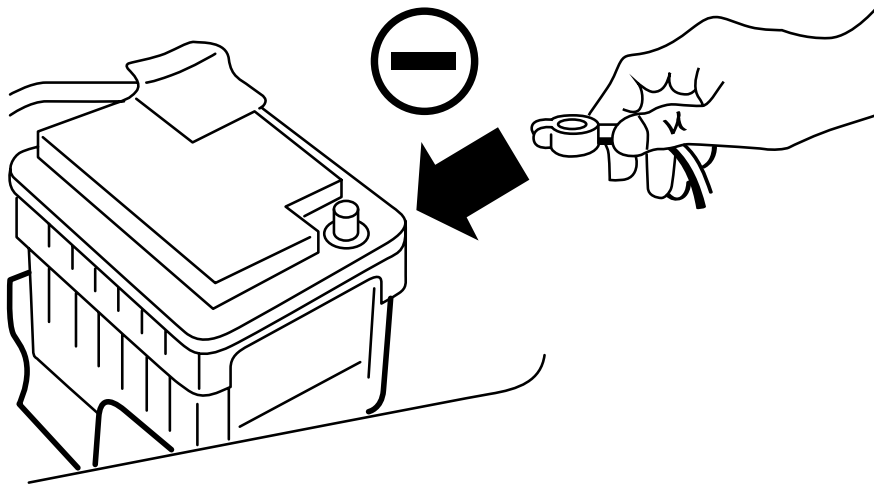

29

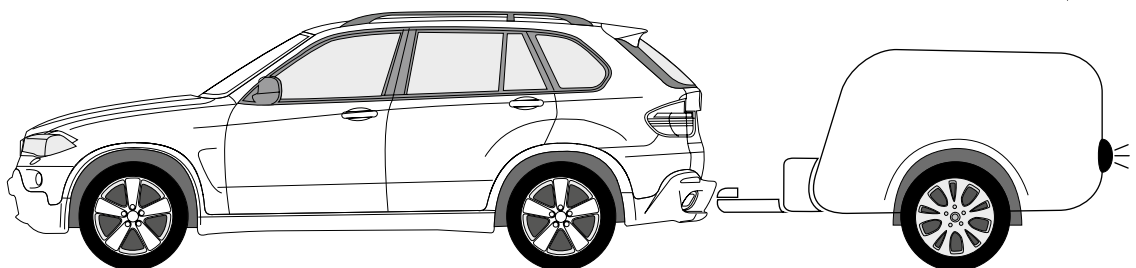
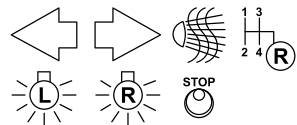

30

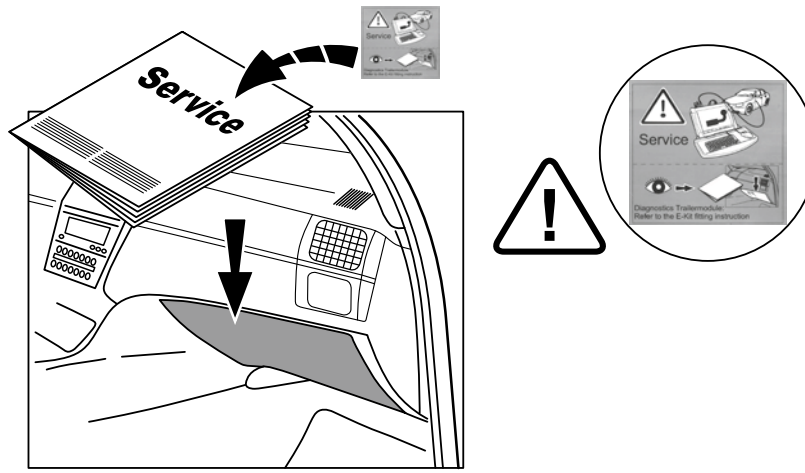

31

