



Safety glasses should be worn at all times while installing this product.

YEARS: 2011-PRESENT

MAKE: FORD

MODEL: EXPLORER

STYLE: SUV

WARNING: NEVER EXCEED YOUR VEHICLE MANUFACTURER'S RECOMMENDED TOWING CAPACITY





WEIGHT CARRYING:
 TRAILER WEIGHT: 4,000 LBS.
 TONGUE WEIGHT: 400 LBS.

WEIGHT DISTRIBUTION:
 TRAILER WEIGHT: 5,000 LBS.
 TONGUE WEIGHT: 500 LBS.

INSTALLATION TIME: 30 MIN.

THE INSTALL TIME LISTED IS FOR PROFESSIONAL INSTALLERS. IF YOU ARE HESITANT TO UNDERTAKE THIS TASK ON YOUR OWN, CONTACT AN AUTHORIZED CURT INSTALLER FOR ADDITIONAL ASSISTANCE.



INSTALLATION REQUIRES:

 RATCHET	 6" SOCKET EXTENSION	 18mm 19mm 3/4" 5/8" SOCKET
 TORQUE WRENCH	 SAFETY GLASSES	

INSTALLATION TIPS:

- BEFORE YOU BEGIN INSTALLATION, READ ALL INSTRUCTIONS THOROUGHLY.
- TO EASE INSTALLATION, 2 PEOPLE MAY BE REQUIRED.
- USING PROPER TOOLS WILL GREATLY IMPROVE THE QUALITY OF THE INSTALL AND REDUCE THE TIME REQUIRED.
- NEED HELP OR HAVE SOME QUESTIONS? CALL TECHNICAL SUPPORT AT 800.798.0813

LEVEL OF DIFFICULTY: EASY

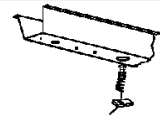
<i>EASY</i>	<i>MODERATE</i>	<i>CHALLENGING</i>
	NO DRILLING REQUIRED	
	LOWER EXHAUST	
	FISHWIRE HARDWARE	

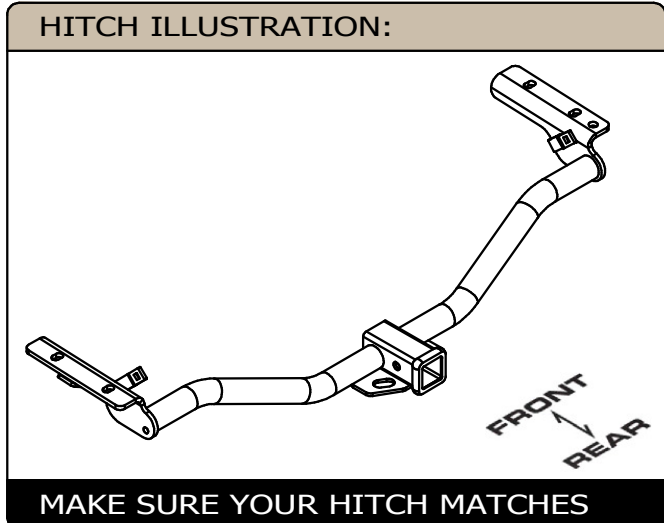

PERIODICALLY CHECK THIS RECEIVER HITCH TO ENSURE ALL FASTENERS ARE TIGHT AND ALL STRUCTURAL COMPONENTS ARE SOUND

CURT Manufacturing Inc. warrants this product to be free of defects in material and/or workmanship at the time of retail purchase by the original purchaser. If the product is found to be defective, Curt Manufacturing Inc. may repair or replace the product at their option, when the product is returned, prepaid, with proof of purchase. Alteration to, misuse of, or improper installation of this product voids the warranty. Curt Manufacturing Inc.'s liability is limited to repair or replacement of products found to be defective, and specifically excludes liability for incidental or consequential loss or damage.

For more information log onto www.curtmfg.com, & for helpful towing tips log onto www.hitchinfo.com

INSTALLATION WALKTHROUGH:

Parts List			
ITEM	QTY	PART NUMBER	DESCRIPTION
1	4	M12-1.75 x 40mm	HEX BOLT
2	4	1/2"	CONICAL TOOTHED WASHER
3	1	1_2 FISHWIRE	1/2" FISHWIRE
4	1	HFN 1213	HEX FLANGE NUT
5	1	CM-SP10	.250 x 1.00 x 2.50" SQUARE HOLE SPACER
6	1	1/2-13 x 1 1/2	CARRIAGE BOLT
7	4	7/16 WASHER	WASHER
8	2	7_16 - 14	NYLOCK HEX NUT
9	2	7_16 - 14 x 2 1_2 HEX	HEX BOLT

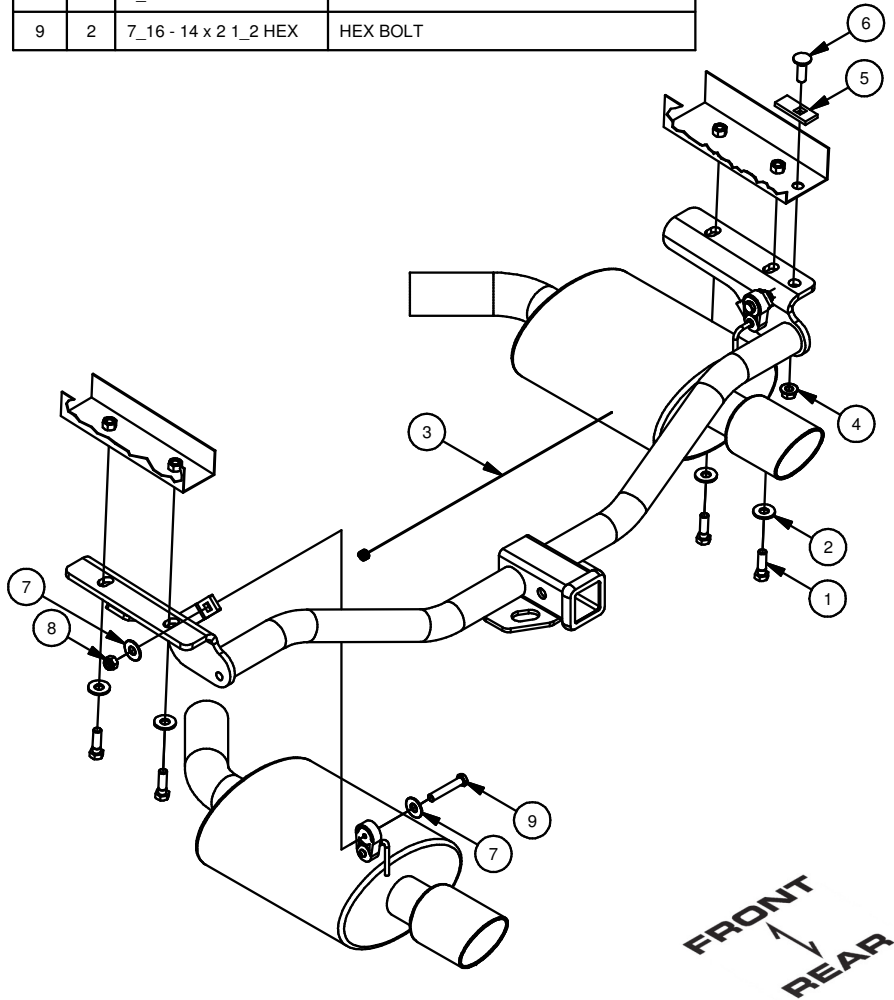

1. Remove (3) rubber isolators to lower exhaust. Use wire to hold exhaust and prevent damage.



2. Remove (2) rubber isolators from muffer. Remove exhaust hanger and/or exhaust hanger with existing tow loop. Return hangers and hardware to vehicle owner.



INSTALLATION WALKTHROUGH:

3. Install rubber isolators from Step 2 onto hitch with 7/16" hex bolts. Secure the isolators with 7/16" flat washers and nylock hex nuts as shown.

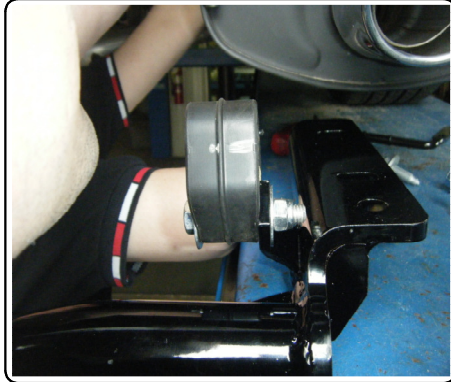

4. Reverse fishwire 1/2" carriage bolt and CM-SP10 spacer through existing hole in passenger side frame rail.

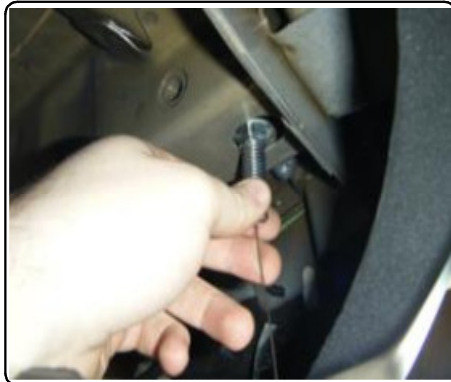

5. Raise hitch into position and secure with supplied M12 hex bolts and 1/2" conical toothed washers into existing vehicle weldnuts. Secure 1/2" carriage bolt with supplied hex flange nut.



6. Torque M12 hardware to 79 lb-ft and 1/2" hardware to 110 lb-ft. Raise exhaust back into position.

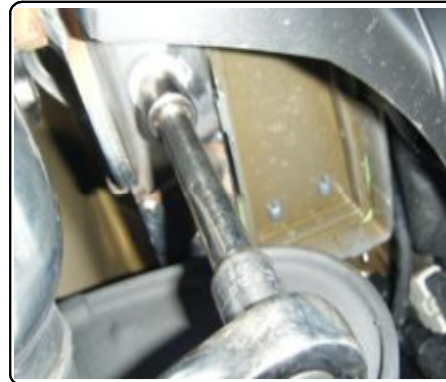

13100

FORD EXPLORER

7/16/2012

GROSS LOAD CAPACITY WHEN USED AS A WEIGHT CARRYING HITCH: 4,000 LBS. TRAILER WEIGHT & 400 LBS. TONGUE WEIGHT. GROSS LOAD CAPACITY WHEN USED AS A WEIGHT DISTRIBUTION HITCH: 5,000 LBS. TRAILER WEIGHT & 500 LBS. TONGUE WEIGHT

DO NOT EXCEED VEHICLE MANUFACTURER'S RECOMMENDED TOWING CAPACITY.

HAVING INSTALLATION QUESTIONS? CALL TECHNICAL SUPPORT AT 1-800-798-0813

		Parts List	
ITEM	QTY	PART NUMBER	DESCRIPTION
1	4	M12-1.75 x 40mm	HEX BOLT
2	4	1/2"	CONICAL TOOTHED WASHER
3	1	1_2 FISHWIRE	1/2" FISHWIRE
4	1	HFN 1213	HEX FLANGE NUT
5	1	CM-SP10	.250 x 1.00 x 2.50" SQUARE HOLE SPACER
6	1	1/2-13 x 1 1/2	CARRIAGE BOLT
7	4	7/16 WASHER	WASHER
8	2	7_16 - 14	NYLOCK HEX NUT
9	2	7_16 - 14 x 2 1_2 HEX	HEX BOLT

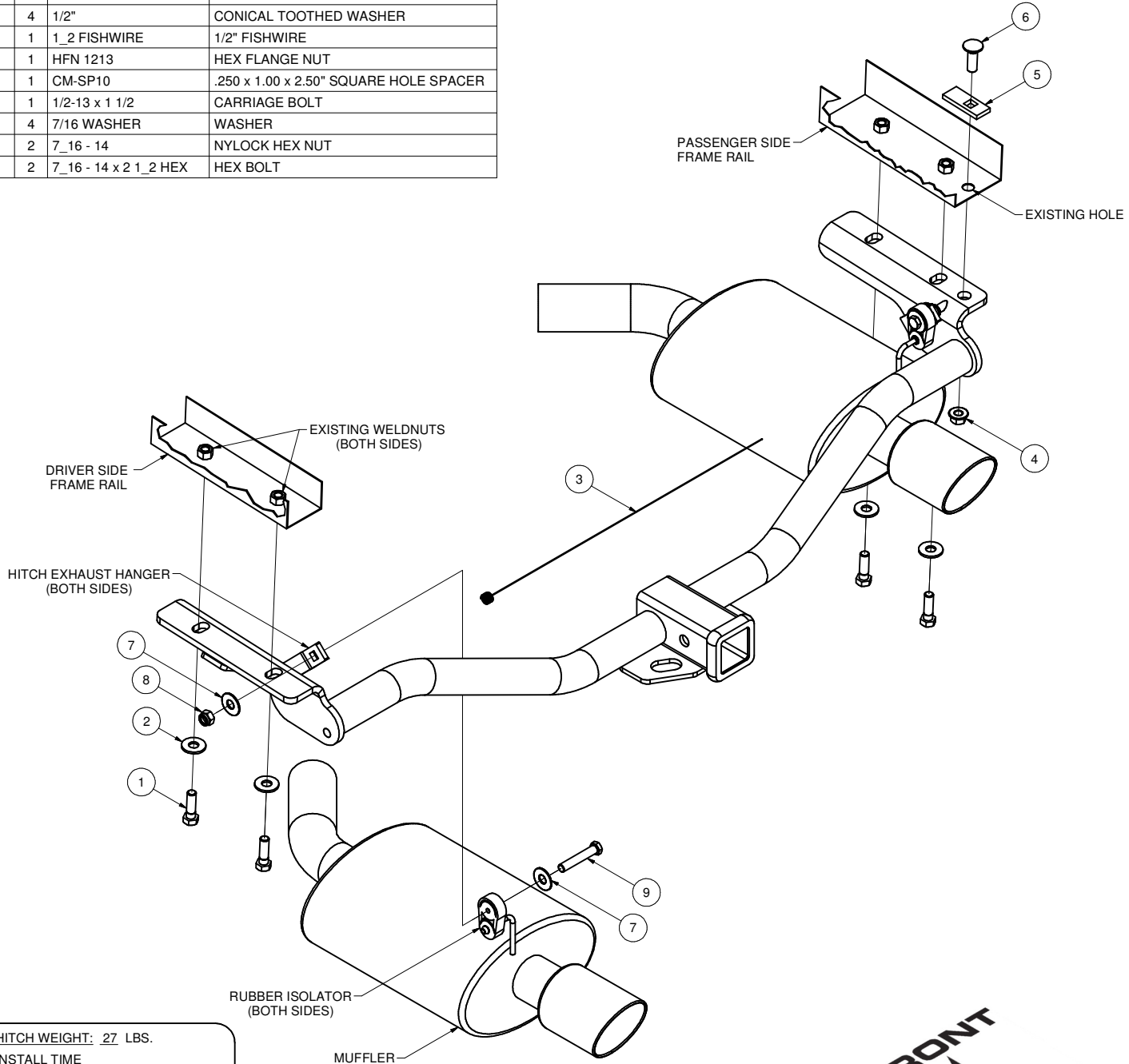

FRONT
↑
REAR

HITCH WEIGHT: 27 LBS.
INSTALL TIME
 PROFESSIONAL: 30 MINUTES
 NOVICE (DIY): 60 MINUTES
INSTALL NOTES:
 - NO DRILLING REQUIRED
 - LOWER EXHAUST
 - FISHWIRE HARDWARE

PERIODICALLY CHECK THIS RECEIVER HITCH TO ENSURE THAT ALL FASTENERS ARE TIGHT AND THAT ALL STRUCTURAL COMPONENTS ARE SOUND.

Curt Manufacturing Inc., warrants this product to be free of defects in material and/or workmanship at the time of retail purchase by the original purchaser. If the product is found to be defective, Curt Manufacturing Inc., may repair or replace the product, at their option, when the product is returned, prepaid, with proof of purchase. Alteration to, misuse of, or improper installation of this product voids the warranty. Curt Manufacturing Inc.'s liability is limited to repair or replacement of products found to be defective, and specifically excludes liability for incidental or consequential loss or damage.

13100**FORD EXPLORER**

7/16/2012

*****DO NOT EXCEED VEHICLE MANUFACTURER'S RECOMMENDED TOWING CAPACITY.*****

HAVING INSTALLATION QUESTIONS? CALL TECHNICAL SUPPORT AT 1-800-798-0813

**REVERSE PULL FISHWIRE
TECHNIQUE**

ATTACH FISHWIRE TO CARRIAGE BOLT AND SLIDE SPACER ONTO FISHWIRE. PUSH THE BOLT THRU THE HOLE FOLLOWED BY THE SPACER (AS SHOWN). PULL BOLT BACK INTO POSITION, PROTRUDING FROM THE FRAME.

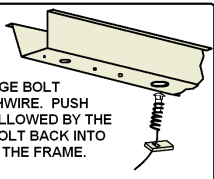
**RUBBER ISOLATOR
REMOVAL DIAGRAM**

This technique can be used if and Exhaust Hanger Removal Pliers is not available.

Using a 5/8" open end wrench, slide the wrench up to the rubber isolator, cradling the hanger rod as shown. Next place the flat edge of a pry bar between the wrench and the hanger stop or hanger rod. Then simply rotate the pry bar toward the wrench to remove the rubber isolator.

Note: Using a spray lubricant or soapy water on the hanger rod and the rubber isolator helps removal.

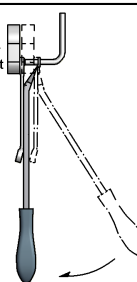
**TOOLS REQUIRED**

RATCHET

6" RATCHET EXTENSION

18mm SOCKET

19mm SOCKET

3/4" SOCKET

5/8" SOCKET

TORQUE WRENCH

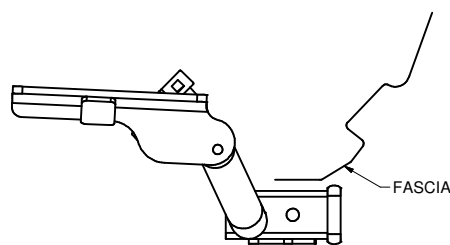
**INSTALLED HITCH POSITION****INSTALLATION STEPS**

1. Remove (3) rubber isolators to lower exhaust. Use wire to hold exhaust and prevent damage. (See Rubber Isolator Removal Diagram.)
2. Remove (2) rubber isolators from muffler.
3. Remove exhaust hanger and/or exhaust hanger with existing tow loop. Return hangers and hardware to vehicle owner.
4. Install rubber isolators from Step 2 onto hitch with 7/16" hex bolts. Secure the isolators with 7/16" flat washers and nylock hex nuts as shown.
5. Reverse fishwire 1/2" carriage bolt and CM-SP10 spacer through existing hole in passenger side frame rail. (See Reverse Pull Fishwire Technique.)
6. Raise hitch into position and secure with supplied M12 hex bolts and 1/2" conical toothed washers into existing vehicle weldnuts.
7. Secure 1/2" carriage bolt with supplied hex flange nut.
8. Torque M12 hardware to 79 lb-ft and 1/2" hardware to 110 lb-ft.
9. Raise exhaust back into position.

PERIODICALLY CHECK THIS RECEIVER HITCH TO ENSURE THAT ALL FASTENERS ARE TIGHT AND THAT ALL STRUCTURAL COMPONENTS ARE SOUND.

Curt Manufacturing Inc., warrants this product to be free of defects in material and/or workmanship at the time of retail purchase by the original purchaser. If the product is found to be defective, Curt Manufacturing Inc., may repair or replace the product, at their option, when the product is returned, prepaid, with proof of purchase. Alteration to, misuse of, or improper installation of this product voids the warranty. Curt Manufacturing Inc.'s liability is limited to repair or replacement of products found to be defective, and specifically excludes liability for incidental or consequential loss or damage.