

FITTING INSTRUCTION

Clamp mark in acc. with		Cables joining
ISO	PN	
1	L	Left directional lights
2	+	Rear fog lights
3	31	Ground
4	R	Right directional lights
5	58R	Right side parking lights
6	54	Stoplights
7	58L	Left side parking lights

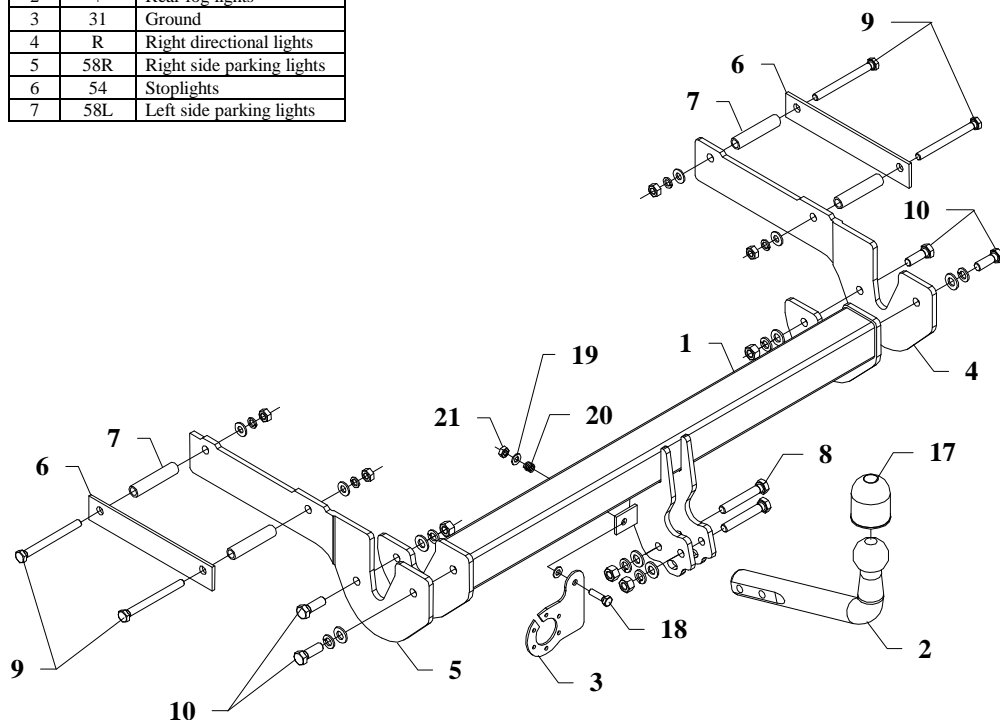

This towbar is designed to assembly in following cars:
FORD MONDEO 4/5 doors, produced since 10.2000 till 12.2006, catalogue no. **C36**, and is prepared to tow trailers max total weight **1800 kg** and max vertical load **75 kg**.

From manufacturer

Thank you for buying our product. Their reliability has been confirmed in many tests. Reliability of towbar depends also on correct assembly and right operation. For this reasons we kindly ask to read carefully this instruction and apply to hints.

The towbar should be install in points described by a car producer.

The instruction of the assembly

1. From below the car, from the right side – unscrew plastic cover plate.
2. Unscrew bumper only from below (long cover overalls). Next put template and make cut according to this template.
3. Get lower the bumper from rear handle and unscrew thermal shield.
4. In chassis members (in adequately places) put sleeves $\varnothing 17$ L=80mm (pos. 7).
5. To the left chassis member (internal side) screw element (pos. 5), marked as C36L, using bolts M10x110mm – pos. 9 (use fish plate – pos. 6).
6. To the right chassis member (internal side) screw element (pos. 4), marked as C36R, using bolts M10x110mm – pos. 9 (use fish plate – pos. 6).
7. To that prepared elements (pos. 4 and 5) screw main bar of towbar (pos. 1) using bolts M12x35mm – pos. 10 (to make this operation easily pull cover overalls).
8. Screw tow-ball (pos. 2) using bolts M12x75mm (pos. 8) from accessories.
9. Fix the socket plate (pos. 3) as shown on the drawing.
10. Tighten all bolts according to the torque shown in the table.
11. Connect electric wires of 7-poles socket according to the instruction of the car. (Recommend to make at authorized service station).
12. Complete the paint coating damaged during installation.

Torque settings for nuts and bolts (8,8):

M6 - 11 Nm	M8 - 25 Nm	M10 - 50 Nm
M12 - 87 Nm	M14 - 138 Nm	M16 - 210 Nm











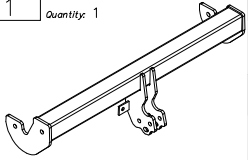
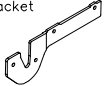

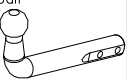

NOTE

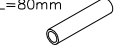
After install the towbar you should get adequate note in registration book (at authorised service station). The car should be equipped with:

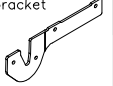
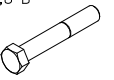
- Indicators
- Tow mirrors

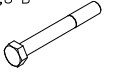
After 1000km of exploitation check all bolts and nuts. The ball of towbar must be always kept clear and conserve with a grease.

Towbar accessories:

Pos. 1 Name: Main bar Quantity: 1	Pos. 5 Name: Left bracket Quantity: 1	Pos. 10 Name: Bolt 8,8 B Quantity: 4 Dim.: M12x35mm	Pos. 16 Name: Spring washer Quantity: 4 Dim.: Ø 10,2 mm
			
Pos. 2 Name: Tow ball Quantity: 1	Pos. 6 Name: Fish-plate Quantity: 2 Dim.: 240x40x5mm	Pos. 11 Name: Nut 8 B Quantity: 4 Dim.: M12	Pos. 17 Name: Ball cover Quantity: 1
			
Pos. 3 Name: Socket plate Quantity: 1	Pos. 7 Name: Distance sleeve Quantity: 4 Dim.: Ø17,2x2,35 L=80mm	Pos. 12 Name: Nut 8 B Quantity: 4 Dim.: M10	Pos. 18 Name: Bolt 8,8 B Quantity: 1 Dim.: M8x30mm
			
Pos. 4 Name: Right bracket Quantity: 1	Pos. 8 Name: Bolt 8,8 B Quantity: 2 Dim.: M12x75mm	Pos. 13 Name: Plain washer Quantity: 6 Dim.: Ø 13 mm	Pos. 19 Name: Plain washer Quantity: 2 Dim.: Ø 8,5 mm
			
	Pos. 9 Name: Bolt 8,8 B Quantity: 4 Dim.: M10x110mm	Pos. 14 Name: Plain washer Quantity: 4 Dim.: Ø 10,5 mm	Pos. 20 Name: Spring Quantity: 1
			
	Pos. 15 Name: Spring washer Quantity: 6 Dim.: Ø 12,2 mm	Pos. 21 Name: Nut 8 B Quantity: 1 Dim.: M8	
			



PPUH AUTO-HAK S. J.

Produkcja Zaczepów Kulowych
Henryk & Zbigniew Nejman
76-200 SŁUPSK ul. Słoneczna 16K
tel/fax (059) 8-414-414; 8-414-413
E-mail: office@autohak.com.pl
www.autohak.com.pl

Towing hitch (without electrical set)

Class: A50-X Cat. no. **C36**

Designed for:

Manufacturer: **FORD**

Model: **MONDEO**

Type: **4-5doors**

produced since 10.2000 till 12.2006

Technical data:

D-value: 9,1 kN

maximum trailer weight: **1800 kg**

maximum vertical cup load: **75 kg**

Approval number acc. to regulations EKG/ONZ 55.01: **E20-55R-01 1150**

Foreword

This towbar is designed according to rules of safety traffic regulations. The towing hitch is a safety component and can be install only by qualified personnel. Any alteration or conversion of the towing hitch is prohibited and would lead to cancellation of design certification. Remove insulating compound and underseal from vehicle (if present) in the area of the matting surfaces of the towing hitch.

The vehicle manufacturer's specifications regarding trailer load and max. vertical cup load are decisive for driving, and values for the towing hitch cannot be exceeded.

D-value formula:

$$\frac{\text{Max trailer weight [kg]} \times \text{Max vehicle weight [kg]}}{\text{Max trailer weight [kg]} + \text{Max vehicle weight [kg]}} \times \frac{9,81}{1000} = D \text{ [kN]}$$