

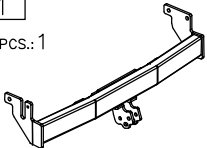

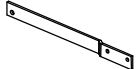

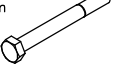





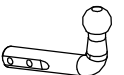

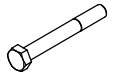

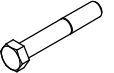

Towbar accessories:

Pos. 1 Main bar PCS.: 1 	Pos. 5 Left bracket PCS.: 1 	Pos. 10 Bolt 8,8 B M10x100mm PCS.: 2 	Pos. 16 Plain washer ø10,5mm PCS.: 6 
Pos. 2 Tow ball PCS.: 1 	Pos. 6 Distance sleeve I ø17x2,35 L=52mm PCS.: 3 	Pos. 11 Bolt 8,8 B M10x90mm PCS.: 1 	Pos. 17 Spring washer ø12,2mm PCS.: 2 
Pos. 3 Socket plate PCS.: 1 	Pos. 7 Distance sleeve II PCS.: 1 	Pos. 12 Bolt 8,8 B M10x40mm PCS.: 1 	Pos. 18 Spring washer ø10,2mm PCS.: 6 
Pos. 4 Right bracket PCS.: 1 	Pos. 8 Bolt 8,8 B M12x75mm PCS.: 1 	Pos. 13 Bolt 8,8 B M10x25mm PCS.: 2 	Pos. 19 Nut 8 B M12 PCS.: 2 
	Pos. 9 Bolt 8,8 B M12x70mm PCS.: 1 	Pos. 14 Plain washer ø13mm PCS.: 3 	Pos. 20 Nut 8 B M10 PCS.: 3 
		Pos. 15 Plain washer ø13mm PCS.: 2 	Pos. 21 Ball cover PCS.: 1 

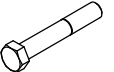

PPUH AUTO-HAK Sp.J.

Produkcja Zaczepów Kulowych
Henryk & Zbigniew Nejman
76-200 SŁUPSK ul. Słoneczna 16K
tel/fax (059) 8-414-414; 8-414-413
E-mail: office@autohak.com.pl
www.autohak.com.pl

Towing hitch (without electrical set)

Class: **A50-X** Cat. no. **G20**

Designed for:

Manufacturer: **RENAULT**

Model: **SAFRANE**

Type: **5 doors**

produced since 1992 till 2001

Technical data:

D-value: 8,91 kN

maximum trailer weight: **1600 kg**

maximum vertical cup mass: **75 kg**

Approval number according to Directive 94/20/EC: e20*94/20*0644*00

Foreword

This towbar is designed according to rules of safety traffic regulations. The towing hitch is a safety component and can be install only by qualified personnel. Any alteration or conversion of the towing hitch is prohibited and would lead to cancellation of design certification. Remove insulating compound and underseal from vehicle (if present) in the area of the matting surfaces of the towing hitch.

The vehicle manufacturer's specifications regarding trailer load and max. vertical cup load are decisive for driving, and values for the towing hitch cannot be exceeded.

D-value formula:

$$\frac{\text{Max trailer weight [kg]} \times \text{Max vehicle weight [kg]}}{\text{Max trailer weight [kg]} + \text{Max vehicle weight [kg]}} \times \frac{9,81}{1000} = D \text{ [kN]}$$

FITTING INSTRUCTION

Clamp mark in acc. with		Cables joining
ISO	PN	
1	L	Left directional lights
2	+	Rear fog lights
3	31	Ground
4	R	Right directional lights
5	58R	Right side parking lights
6	54	Stoplights
7	58L	Left side parking lights

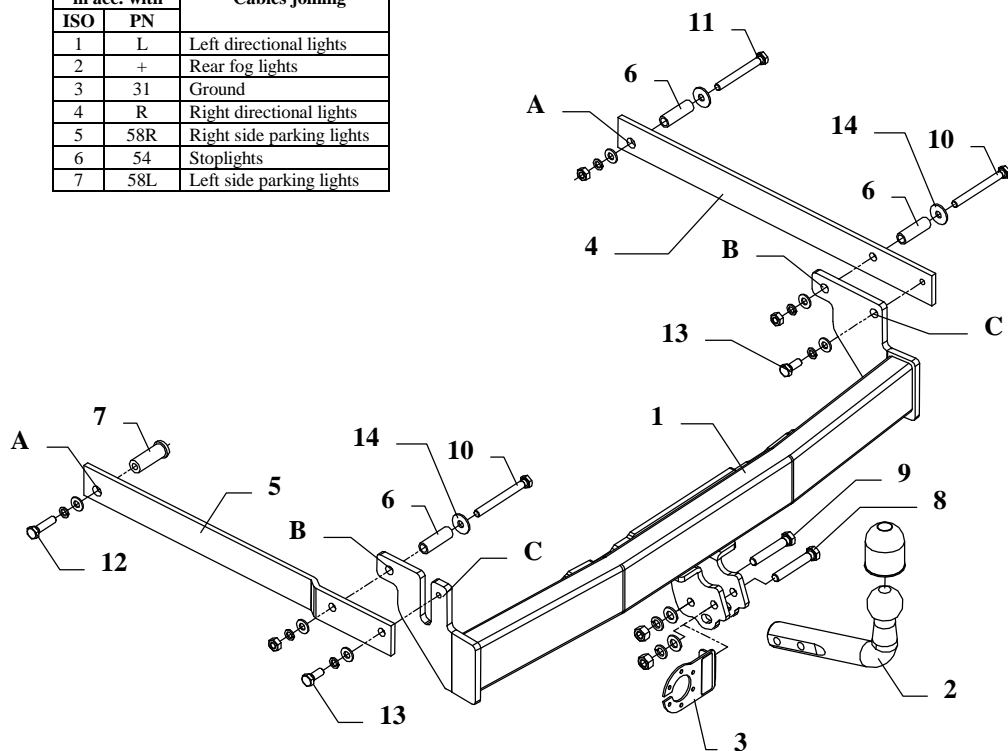

This towbar is designed to assembly in following cars:
RENAULT SAFRANE 5 doors, produced since 1992 till 2001, catalogue no. **G20** and is prepared to tow trailers max total weight **1600 kg** and max vertical mass **75 kg**.

From manufacturer

Thank you for buying our product. Their reliability has been confirmed in many tests. Reliability of towbar depends also on correct assembly and right operation. For this reasons we kindly ask to read carefully this instruction and apply to hints.

The towbar should be install in points described by a car producer.

The instruction of the assembly

1. To install the towbar one ought to disassemble the bumper.
2. Into factory-made holes in chassis members put distance sleeves (pos. 6 and 7) from the towbar accessories (see the fig.).
3. Through distance sleeves (pos. 6 and 7) with reasonable tight fix side brackets (pos. 4 and 5). Use holes (pos. A) in brackets.
4. From the bottom of the car apply the main bar of the towbar (pos. 1) and fix through distance sleeves (pos. 6) and holes (pos. B) with installed side brackets (pos. 4 and 5) using bolts M10x100mm (pos. 10).
5. Through holes (pos. C) fix side brackets with installed main bar of the towbar using bolts M10x25mm (pos. 13).
6. Tighten all bolts according to the torque shown in the table.
7. In the central point of the bumper (from the bottom) cut out the fragment 50x30mm and then install the bumper.
8. To so prepared towbar fix tow-ball (pos. 2) and socket plate (pos. 3) by bolts M12x75mm (pos. 8) and M12x70mm (pos. 9) from accessories.
9. Connect electric wires of 7-poles socket according to the instruction of the car. (Recommend to make at authorized service station).
10. Complete paint layer damaged during installation.

Torque settings for nuts and bolts (8,8):

M6 - 11 Nm	M8 - 25 Nm	M10 - 50 Nm
M12 - 87 Nm	M14 - 138 Nm	M16 - 210 Nm

NOTE

After install the towbar you should get adequate note in registration book (at authorised service station).The car should be equipped with:

- Indicators
- Tow mirrors

After 1000km of exploitation check all bolts and nuts. The ball of towbar must be always kept clear and conserve with a grease.