

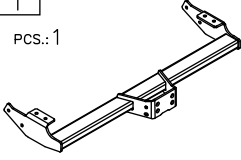















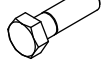

Towing hitch equipment:

Pos. 1 Main bar PCS.: 1 	Pos. 5 Right handle pcs.: 1 	Pos. 10 Bolt 8,8 B M10x30mm PCS.:1 	Pos. 15 Spring washer ø12mm PCS.:6 
	Pos. 6 Left handle pcs.: 1 	Pos. 11 Plain washer ø17mm PCS.:2 	Pos. 16 Spring washer ø10mm PCS.:7 
Pos. 2 Tow ball pcs.: 1 	Pos. 7 Bolt 8,8 B M16x50mm PCS.:2 	Pos. 12 Plain washer ø12mm PCS.:6 	Pos. 17 Nut 8 B M16 PCS.:2 
Pos. 3 Socket plate pcs.: 1 	Pos. 8 Bolt 8,8 B M12x35mm PCS.:6 	Pos. 13 Plain washer ø10mm PCS.:7 	Pos. 18 Nut 8 B M12 PCS.:6 
Pos. 4 Arm pcs.: 2 	Pos. 9 Bolt 8,8 B M10x35mm PCS.:6 	Pos. 14 Spring washer ø16mm PCS.:2 	Pos. 19 Nut 8 B M10 PCS.:1 
			Pos. 20 Ball cover PCS.:1 

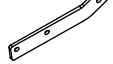

PPUH AUTO-HAK Sp.J.

Produkcja Zaczepów Kulowych
Henryk & Zbigniew Nejman
76-200 SŁUPSK ul. Słoneczna 16K
tel/fax (059) 8-414-414; 8-414-413
E-mail: office@autohak.com.pl
www.autohak.com.pl

Towing hitch (without electrical set)

Class: **A50-X** Cat. no. **G40**

Designed for:
RENAULT TRAFIC T
Model: **metal, built up**

OPEL VIVARO
Model: **metal, built up**
Both produced since 2001 and

NISSAN PRIMASTAR
Model: **metal, built up**
produced since 2003

Technical data:

D-value: 12,3 kN
maximum trailer weight: **2100 kg**
maximum vertical cup mass: **100 kg**

Approval number acc. to regulations EKG/ONZ 55.01: **E20-55R-01 0797**

Foreword

This towing hitch is designed according to rules of safety traffic regulations. The towing hitch is a safety component and can be install only by qualified personnel. Any alteration or conversion of the towing hitch is prohibited and would lead to cancellation of design certification. Remove insulating compound and underseal from vehicle (if present) in the area of the matting surfaces of the towing hitch.

The vehicle manufacturer's specifications regarding trailer mass and max. vertical cup mass are decisive for driving whereat values for the towing hitch cannot be exceeded.

D-value formula:

$$\frac{\text{Max trailer weight [kg]} \times \text{Max vehicle weight [kg]}}{\text{Max trailer weight [kg]} + \text{Max vehicle weight [kg]}} \times \frac{9,81}{1000} = D \text{ [kN]}$$

FITTING INSTRUCTION

Clamp mark in acc. with		Cables joining
ISO	PN	
1	L	Left directional lights
2	+	Rear fog lights
3	31	Ground
4	R	Right directional lights
5	58R	Right side parking lights
6	54	Stoplights
7	58L	Left side parking lights

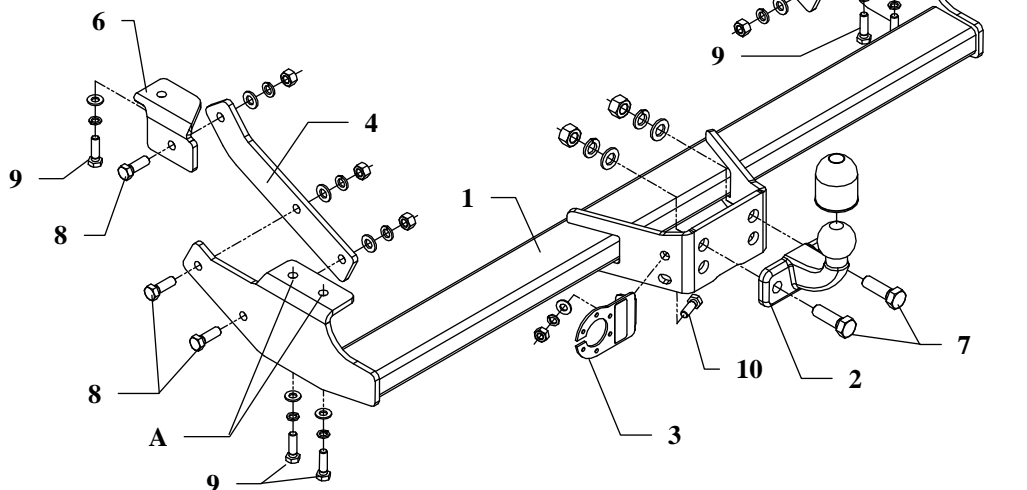

This towing hitch is designed to assembly in following cars: **RENAULT TRAFIC T, metal built-up** and **OPEL VIVARO, metal built-up**, both produced since 2001 and **NISSAN PRIMASTAR , metal built-up**, produced since 2003, catalogue no. **G40** and is prepared to tow trailers max total weight **2100 kg** and max vertical mass **100 kg**.

From manufacturer

Thank you for buying our product. Their reliability has been confirmed in many tests. Reliability of towing hitch depends also on correct assembly and right operation. For this reasons we kindly ask to read carefully this instruction and apply to hints.

The towing hitch should be installing in points described by a car producer.

The instruction of the assembly

1. Position the main bar of the towing hitch (pos. 1) to the car frame and fix it through the holes pos. A using bolts M10x35mm (pos. 9).
2. Position side handles (pos. 5 and 6) in the car frame and fix it using bolts M10x35mm (pos. 9), see the drawing.
3. Fix arms (pos. 4) to the mounted side handles (pos. 5 and 6) using bolts M12x35mm (pos. 8), see the drawing.
4. Fix tow ball of towbar (pos. 2) by two bolt M16x50mm (pos. 7) from the towbar equipment.
5. Fix socket plate (pos. 3) by bolt M10x30mm (pos. 10) as shown on the drawing.
6. Tighten all nuts and bolts according to the torque shown in the table
7. Connect electric wires of 7-poles socket according to the instruction of the car. (Recommend to make at authorized service station).
8. Complete paint layer damaged during installation.

Torque settings for nuts and bolts (8,8):

M6 - 11 Nm	M8 - 25 Nm	M10 - 50 Nm
M12 - 87 Nm	M14 - 138 Nm	M16 - 210 Nm

NOTE

After install the towing hitch you should get adequate note in registration book (at authorised service station). The car should be equipped with:

- Indicators
- Tow mirrors

After 1000km of exploitation check all bolts and nuts. The ball of towing hitch must be always kept clear and conserve with a grease.