

FITTING INSTRUCTION

Clamp mark in acc. with		Cables joining
ISO	PN	
1	L	Left directional lights
2	+	Rear fog lights
3	31	Ground
4	R	Right directional lights
5	58R	Right side parking lights
6	54	Stoplights
7	58L	Left side parking lights

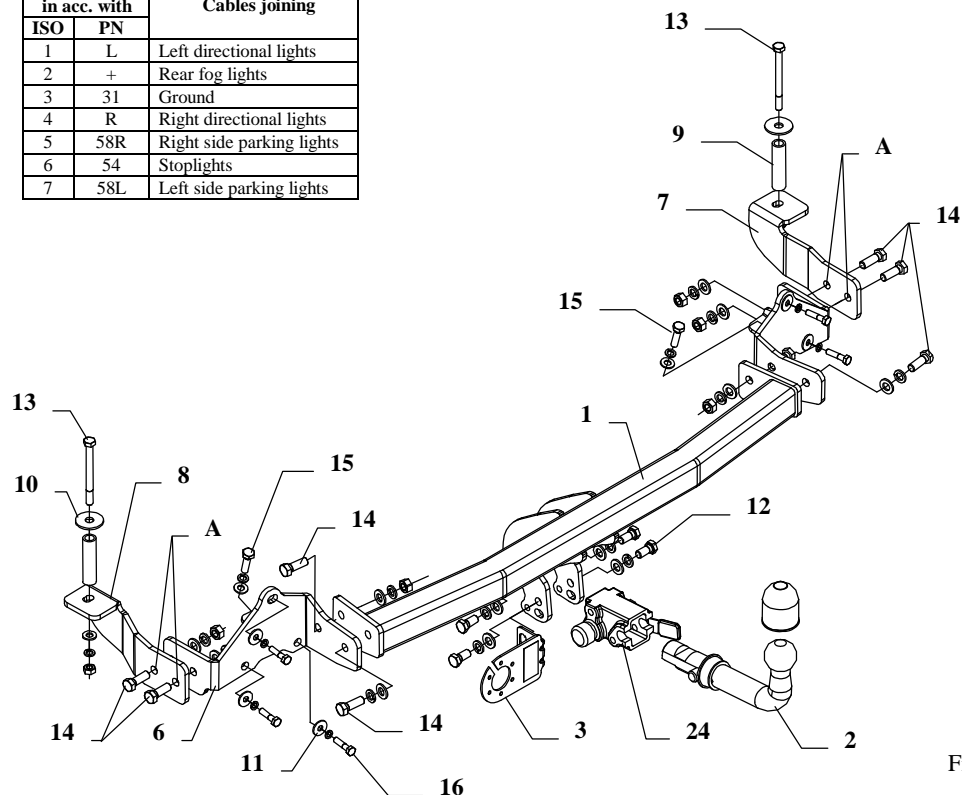

Fig. 1

This towbar is designed to assembly in following cars: **FIAT DOBLO also MAXI**, produced since 2001 till 11.2009, catalogue no. **R27A** and is prepared to tow trailers max total weight **1300 kg** and max vertical load **60 kg**.

From manufacturer

Thank you for buying our product. Their reliability has been confirmed in many tests. Reliability of towbar depends also on correct assembly and right operation. For this reasons we kindly ask to read carefully this instruction and apply to hints.

The towbar should be install in points described by a car producer.

The instruction of the assembly

1. Disassemble the bumper.
2. Disassemble the metal strengthener (will not be assembled again).
3. From under the car, on the transverse frame, are a plastic fuses in the left and right side. Open it an then, form inside of the carrier, put out the rubber dummy. It in this way get through holes, and then put from the under side the tubes $\varnothing 20 \times 3$, L=80mm (pos. 9), and twist with bolts M10x110mm (pos. 13) and washer (pos. 10), as showed on the drawing.

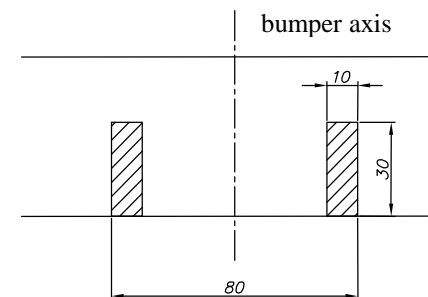

Fig. 2 Cut area

4. In the place previously metal strengthener, put the elements (pos. 5 and 6) and twist with bolts M8x35mm (pos. 16) from the front, and form under of this, with bolts M10x35mm (pos. 15) - loosely.
5. For this way prepared elements, put the main bar of the towbar (pos. 1) and twist with bolts M12x35mm (pos. 14).
6. To elements (pos. 5 and 6) through the holes (pos. A) fix the brackets (pos. 7 and 8) with bolts M12x35mm (pos. 14) and previously put bolts M10x110mm (pos. 13) and twist with chassis member.
7. Fix tight, all nuts and bolts with the moment showed in the table.
8. Mount the bumper after previous cut a fragment, how is showed on fig. 2.
9. To the installed bar fix body of the automat (pos. 24) and the socket plate (pos. 3) using bolts M12x25mm (pos. 12) from accessories. Place tow-ball (pos. 2) according to supplied instruction.
10. Connect the kit wires to the electric installation, in accordance of the instructions of the car.
11. Complete the possible decreases of the paint cover of towbar, originate during the mounting.

Torque settings for nuts and bolts (8,8):

M6 - 11 Nm	M8 - 25 Nm	M10 - 50 Nm
M12 - 87 Nm	M14 - 138 Nm	M16 - 210 Nm











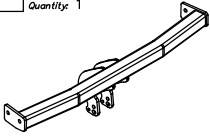



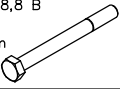

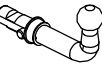







NOTE

After install the towbar you should get adequate note in registration book (at authorised service station).The car should be equipped with:

- Indicators
- Tow mirrors

After 1000km of exploitation check all bolts and nuts. The ball of towbar must be always kept clear and conserve with a grease.

Towbar accessories:

Pos. 1 Name: Main bar Quantity: 1 	Pos. 6 Name: Bracket Quantity: 1 LEFT 	Pos. 12 Name: Bolt 8,8 B Quantity: 4 Dim.: M12x25mm 	Pos. 19 Name: Plain washer Quantity: 12 Dim.: Ø 13 mm 
	Pos. 7 Name: Side bracket Quantity: 1 RIGHT 	Pos. 13 Name: Bolt 8,8 B Quantity: 2 Dim.: M10x110mm 	Pos. 20 Name: Plain washer Quantity: 4 Dim.: Ø 10,5 mm 
Pos. 2 Name: Tow ball Quantity: 1 	Pos. 8 Name: Side bracket Quantity: 1 LEFT 	Pos. 14 Name: Bolt 8,8 B Quantity: 8 Dim.: M12x35mm 	Pos. 21 Name: Spring washer Quantity: 12 Dim.: Ø 12,2 mm 
Pos. 3 Name: Socket plate Quantity: 1 	Pos. 9 Name: Distance sleeve Quantity: 2 Dim.: Ø20x3mm L=80mm 	Pos. 15 Name: Bolt 8,8 B Quantity: 2 Dim.: M10x35mm 	Pos. 22 Name: Spring washer Quantity: 4 Dim.: Ø 10,2 mm 
Pos. 4 Name: Ball cover Quantity: 1 	Pos. 10 Name: Washer Quantity: 2 Dim.: Ø42xØ13x3mm 	Pos. 16 Name: Bolt 8,8 B Quantity: 6 Dim.: M8x35mm 	Pos. 23 Name: Spring washer Quantity: 6 Dim.: Ø 8,2 mm 
Pos. 5 Name: Bracket Quantity: 1 RIGHT 	Pos. 11 Name: Washer Quantity: 6 Dim.: Ø25xØ9x2mm 	Pos. 17 Name: Nut 8 B Quantity: 6 Dim.: M12 	Pos. 24 Name: Body of the automat Quantity: 1 
		Pos. 18 Name: Nut 8 B Quantity: 2 Dim.: M10 	Pos. 25 Name: Body plug Quantity: 1 



PPUH AUTO-HAK Sp.J.

Produkcja Zaczeów Kulowych
Henryk & Zbigniew Nejman
76-200 SŁUPSK ul. Słoneczna 16K
tel/fax (059) 8-414-414; 8-414-413
E-mail: office@autohak.com.pl
www.autohak.com.pl

Towing hitch (without electrical set)

Class: **A50-X** Cat. no. **R27A**

Designed for:

Manufacturer: **FIAT**

Model: **DOBLO also MAXI**

produced since 2001 till 11.2009

Technical data:

D-value: 7,9 kN

maximum trailer weight: **1300 kg**

maximum vertical cup load: **60 kg**

Approval number according to Directive 94/20/EC: **e20*94/20*0813*00**

Foreword

This towbar is designed according to rules of safety traffic regulations. The towing hitch is a safety component and can be install only by qualified personnel. Any alteration or conversion of the towing hitch is prohibited and would lead to cancellation of design certification. Remove insulating compound and underseal from vehicle (if present) in the area of the matting surfaces of the towing hitch.

The vehicle manufacturer's specifications regarding trailer load and max. vertical cup load are decisive for driving, and values for the towing hitch cannot be exceeded.

D-value formula:

$$\frac{\text{Max trailer weight [kg]} \times \text{Max vehicle weight [kg]}}{\text{Max trailer weight [kg]} + \text{Max vehicle weight [kg]}} \times \frac{9,81}{1000} = D \text{ [kN]}$$