

FITTING INSTRUCTION

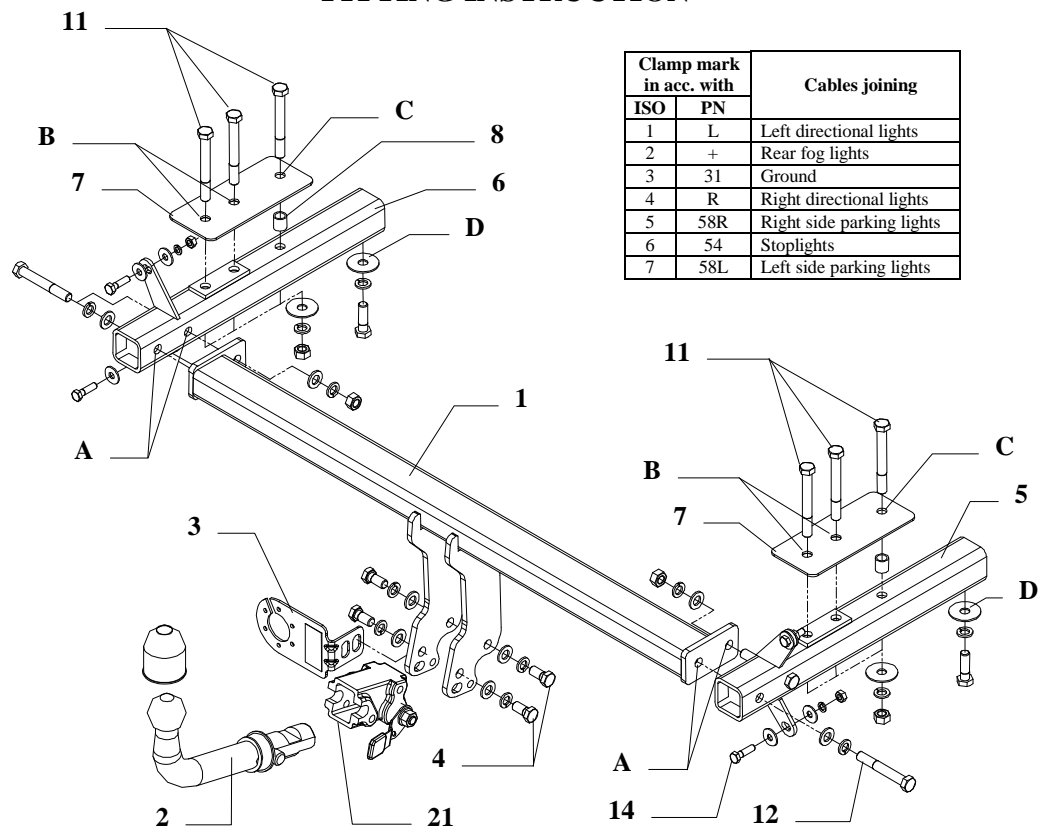

Clamp mark in acc. with		Cables joining
ISO	PN	
1	L	Left directional lights
2	+	Rear fog lights
3	31	Ground
4	R	Right directional lights
5	58R	Right side parking lights
6	54	Stoplights
7	58L	Left side parking lights

The instruction of the assembly

1. Lower the exhaust then remove the rear lights.
2. Remove the floor cover of the luggage trunk then loose the side plastic covers and fold them to the center of the trunk.
3. Remove the bumper and its inset then remove the bumper brackets (these will not be reinstalled later).
4. Enlarge the „C” factory holes on the floor plate of the trunk with a $\varnothing 18\text{mm}$ drill.
5. Put side brackets (pos. 5 and 6) into the chassis extension then according to the drawing loosely fix them at positions „B”, „C” and „D” with the attached bonding units (The accessory plates pos. 7 will be placed into the trunk, remember about distance sleeves pos. 8!).
6. According to the drawing loosely fix main bar of the towbar (1) to the brackets 5 and 6 at positions „A” with bolts M12x85mm (pos. 12).
7. Using bolts M8x30mm (pos. 14) fix inset of the bumper.
8. Fix body of the automat (pos. 21) and the socket plate (pos. 3) using bolts M12x25mm (pos. 4) from accessories. Place tow-ball (pos. 2) according to supplied instruction.
9. Tighten all bolts according to the torque shown in the table.
10. Reassemble bumper after cut out his fragment (80x35mm) in his bottom, central part. Next reassemble the rear lights.
11. Connect electric wires of 7-poles socket according to the instruction of the car. (Recommend to make at authorized service station)
12. Complete paint layer damaged during installation.

This towbar is designed to assembly in following car: **KIA CARENS** produced since 09.2001 till 10.2006, catalogue no. **T43** and is prepared to tow trailers max total weight **1250 kg** and max vertical load **75 kg**.

From manufacturer

Thank you for buying our product. Their reliability has been confirmed in many tests. Reliability of towbar depends also on correct assembly and right exploit. For this reasons we kindly ask to read carefully this instruction and apply to hints.

The towbar should be install in points described by a car producer.

Torque settings for nuts and bolts (8,8):

M6 - 11 Nm	M8 - 25 Nm	M10 - 50 Nm
M12 - 87 Nm	M14 - 138 Nm	M16 - 210 Nm











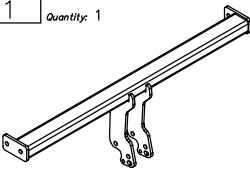

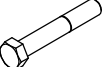



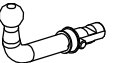

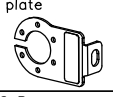

NOTE

After install the towbar you should get adequate note in registration book (at authorised service station).The car should be equipped with:

- Indicators
- Tow mirrors

After 1000km of exploitation check all bolts and nuts. The ball of towbar must be always kept clear and conserve with a grease.

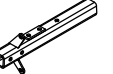
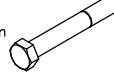
Towbar accessories:

Pos. 1 Name: Main bar Quantity: 1 	Pos. 6 Name: Left bracket Quantity: 1 	Pos. 12 Name: Bolt 8,8 B Quantity: 4 Dim.: M12x85mm 	Pos. 18 Name: Spring washer Quantity: 16 Dim.: Ø 12,2 mm 
	Pos. 7 Name: Fish-plate Quantity: 2 	Pos. 13 Name: Bolt 8,8 B Quantity: 2 Dim.: M12x40mm 	Pos. 19 Name: Spring washer Quantity: 4 Dim.: Ø 8,2 mm 
Pos. 2 Name: Tow ball Quantity: 1 	Pos. 8 Name: Distance sleeve Quantity: 2 Dim.: Ø17.2x2, L=18mm 	Pos. 14 Name: Bolt 8,8 B Quantity: 4 Dim.: M8x30mm 	Pos. 20 Name: Ball cover Quantity: 1 
Pos. 3 Name: Socket plate Quantity: 1 	Pos. 9 Name: Washer Quantity: 8 Dim.: Ø37xØ12.5x3mm 	Pos. 15 Name: Nut 8 B Quantity: 8 Dim.: M12 	Pos. 21 Name: Body of the automat Quantity: 1 
Pos. 4 Name: Bolt 8,8 B Quantity: 4 Dim.: M12x25mm 	Pos. 10 Name: Washer Quantity: 8 Dim.: Ø24xØ8.4x2mm 	Pos. 16 Name: Nut 8 B Quantity: 4 Dim.: M8 	Pos. 22 Name: Body plug Quantity: 1 
Pos. 5 Name: Right bracket Quantity: 1 	Pos. 11 Name: Bolt 8,8 B Quantity: 6 Dim.: M12x100mm 	Pos. 17 Name: Plain washer Quantity: 8 Dim.: Ø 13 mm 	



PPUH AUTO-HAK Sp.J.

Produkcja Zaczepów Kulowych
Henryk & Zbigniew Nejman
76-200 SŁUPSK ul. Słoneczna 16K
tel/fax (059) 8-414-414; 8-414-413
E-mail: office@autohak.com.pl
www.autohak.com.pl

Towing hitch (without electrical set)

Class: **A50-X** Cat. no. **T43A**

Designed for:

Manufacturer: **KIA**

Model: **CARENS**

produced since 09.2001 till 10.2006

Technical data:

D-value: 7,6 kN

maximum trailer weight: **1250 kg**

maximum vertical cup load: **75 kg**

Approval number according to Directive 94/20/EC: e20*94/20*1019*00

Foreword

This towbar is designed according to rules of safety traffic regulations. The towing hitch is a safety component and can be install only by qualified personnel. Any alteration or conversion of the towing hitch is prohibited and would lead to cancellation of design certification. Remove insulating compound and underseal from vehicle (if present) in the area of the matting surfaces of the towing hitch. The vehicle manufacturer's specifications regarding trailer load and max. vertical cup load are decisive for driving whereat values for the towing hitch cannot be exceeded.

D-value formula:

$$\frac{\text{Max trailer weight [kg]} \times \text{Max vehicle weight [kg]}}{\text{Max trailer weight [kg]} + \text{Max vehicle weight [kg]}} \times \frac{9,81}{1000} = D \text{ [kN]}$$