

## FITTING INSTRUCTION

Clamp mark in acc. with		Cables joining
ISO	PN	
1	L	Left directional lights
2	+	Rear fog lights
3	31	Ground
4	R	Right directional lights
5	58R	Right side parking lights
6	54	Stoplights
7	58L	Left side parking lights

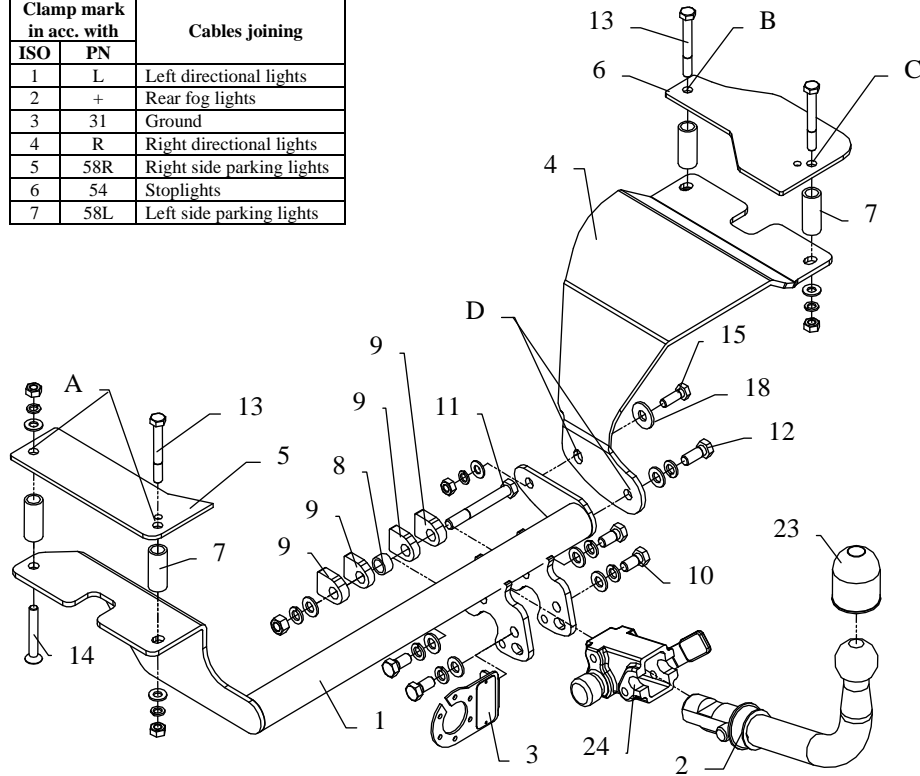

This towbar is designed to assembly in following cars:  
**SUZUKI SWIFT** produced since 2005 till 08.2010, catalogue no. **W21A**  
 and is prepared to tow trailers max total weight **1100kg** and max vertical  
 load **50kg**.

*From manufacturer*

Thank you for buying our product. Their reliability has been confirmed in many tests. Reliability of towbar depends also on correct assembly and correct exploitation. For this reasons we kindly ask to read carefully this instruction and apply to hints.

*The towbar should be install in points described by a car producer.*

## The instruction of the assembly

- Disassemble the rear bumper.
- Fold the backseats forward, then fold up the trunk upholstery.
- Loosen the fuel hose support in the lower side of left-side undercarriage extension..
- Find original plugged holes in the trunk on the left side (pos. A) and drill it using bit  $\varnothing 10\text{mm}$ , then enlarge it to  $\varnothing 21\text{mm}$ . In holes put distance sleeves (pos. 7).
- Mark floor of the trunk underneath the car in point B and drill using bit  $\varnothing 10\text{mm}$ .
- Inside the trunk put fish-plate (pos. 6) on hole B, put bolt M10x80mm. Then mark point C, take out fish-plate and drill  $\varnothing 10\text{mm}$ . Holes pos. B and C enlarge to  $\varnothing 21\text{mm}$  and put distance sleeves pos. 7.
- Put bracket (pos. 4) above the exhaust and fix with fish-plate (pos. 6) using bolts M10x80mm (pos. 13) – loosely.
- Main bar of the towbar fix loosely with towing eye – see figure. Distance sleeve (pos. 8) and distance plate (pos. 9) place between ball brackets.
- Fish-plate (pos. 5) put on holes (pos. A) and fix with main bar (pos. 1) using bolt M10x80mm (pos. 13) and countersunk bolt M10x90mm (pos. 14).
- Fix main bar (pos. 1) to bracket (pos. 4) using bolts M12x30mm and M10x30mm (pos. 12 and 15).
- Fix body of the automat (pos. 24) and the socket plate (pos. 3) using bolts M12x25mm (pos. 10) from accessories. Place tow-ball (pos. 2) according to supplied instruction.
- Reassemble the bumper after cut out his fragment.
- Tighten all bolts according to the torque shown in the table.
- Connect electric wires of 7-poles socket according to the instruction of the car.  
(Recommend to make at authorized service station)
- Complete paint layer damaged during installation.

Torque settings for nuts and bolts (8,8):

<b>M 8</b>	25 Nm	<b>M 10</b>	55 Nm
<b>M 12</b>	85 Nm	<b>M 14</b>	135 Nm











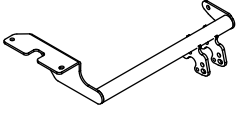



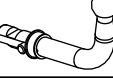







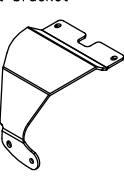

### NOTE

After install the towbar you should get adequate note in registration book (at authorised service station).The car should be equipped with:

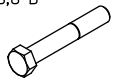
- Indicators
- Tow mirrors

After 1000km of exploitation check all bolts and nuts. The ball of towbar must be always kept clear and conserve with a grease.

## Towbar accessories:

Pos. 1 Name: Main bar Quantity: 1 	Pos. 6 Name: Right overlay Quantity: 1 	Pos. 13 Name: Bolt 8,8 B Quantity: 4 Dim.: M10x80mm 	Pos. 20 Name: Plain washer Quantity: 5 Dim.: Ø 10,5 mm 
Pos. 2 Name: Tow ball Quantity: 1 	Pos. 7 Name: Distance sleeve Quantity: 4 	Pos. 14 Name: Bolt DIN7991 Quantity: 1 Dim.: M10x90mm 	Pos. 21 Name: Spring washer Quantity: 6 Dim.: Ø 12,2 mm 
Pos. 3 Name: Socket plate Quantity: 1 	Pos. 8 Name: Distance sleeve Quantity: 1 	Pos. 15 Name: Bolt 8,8 B Quantity: 1 Dim.: M10x30mm 	Pos. 22 Name: Spring washer Quantity: 5 Dim.: Ø 10,2 mm 
Pos. 4 Name: Right bracket Quantity: 1 	Pos. 9 Name: Distance washer Quantity: 4 	Pos. 16 Name: Nut 8 B Quantity: 1 Dim.: M12 	Pos. 23 Name: Ball cover Quantity: 1 
	Pos. 10 Name: Bolt 8,8 B Quantity: 4 Dim.: M12x25mm 	Pos. 17 Name: Nut 8 B Quantity: 5 Dim.: M10 	Pos. 24 Name: Body of the automat Quantity: 1 
	Pos. 11 Name: Bolt 8,8 B Quantity: 1 Dim.: M12x95mm 	Pos. 18 Name: Washer Quantity: 1 Dim.: Ø32xØ12x3mm 	Pos. 25 Name: Body plug Quantity: 1 
Pos. 5 Name: Left overlay Quantity: 1 	Pos. 12 Name: Bolt 8,8 B Quantity: 1 Dim.: M12x30mm 	Pos. 19 Name: Plain washer Quantity: 6 Dim.: Ø 13 mm 	



## PPUH AUTO-HAK S.J.

Produkcja Zaczepów Kulowych  
Henryk & Zbigniew Nejman  
76-200 SŁUPSK ul. Słoneczna 16K  
tel/fax (059) 8-414-414; 8-414-413  
E-mail: office@autohak.com.pl  
www. autohak.com.pl

### Towing hitch (without electrical set)

Class: **A50-X** Cat. no. **W21A**

Designed for:

Manufacturer: **SUZUKI**

Model: **SWIFT**

produced since 2005 till 08.2010

Technical data:

**D-value: 6,4 kN**

maximum trailer weight: **1100 kg**

maximum vertical cup load: **50 kg**

**Approval number acc. to regulations EKG/ONZ 55.01: E20-55R-01 1793**

### Foreword

This towbar is designed according to rules of safety traffic regulations. The towing hitch is a safety component and can be install only by qualified personnel. Any alteration or conversion of the towing hitch is prohibited and would lead to cancellation of design certification. Remove insulating compound and underseal from vehicle (if present) in the area of the matting surfaces of the towing hitch.

The vehicle manufacturer's specifications regarding trailer load and max. vertical cup load are decisive for driving, and values for the towing hitch cannot be exceeded.

*D-value formula:*

$$\frac{\text{Max trailer weight [kg]} \times \text{Max vehicle weight [kg]}}{\text{Max trailer weight [kg]} + \text{Max vehicle weight [kg]}} \times \frac{9,81}{1000} = D \text{ [kN]}$$