

## FITTING INSTRUCTION

Clamp mark in acc. with		Cables joining
ISO	PN	
1	L	Left directional lights
2	+	Rear fog lights
3	31	Ground
4	R	Right directional lights
5	58R	Right side parking lights
6	54	Stoptlights
7	58L	Left side parking lights

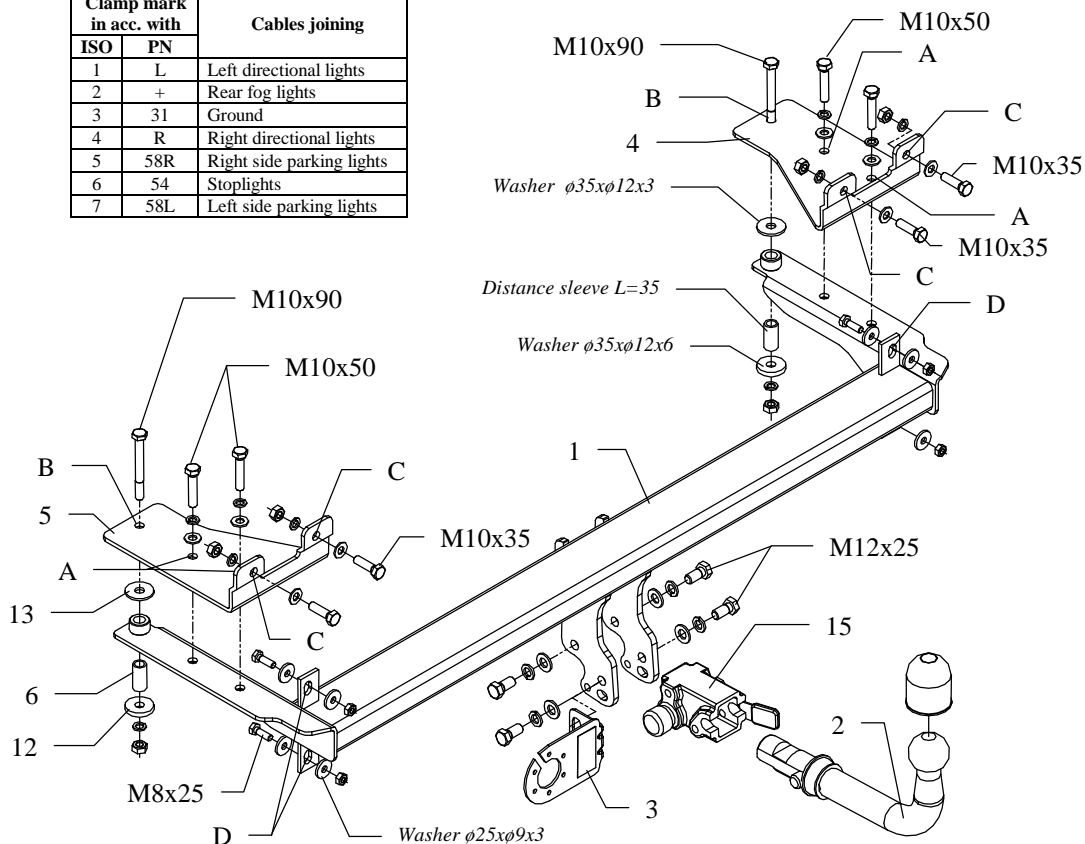

This towbar is designed to assembly in following car:  
**DAEWOO LEGANZA 4 door**, produced since 1997 till 2003, catalogue number **X10** and is prepared to tow trailers max total weight **1500 kg** and max vertical load **75 kg**.

### From manufacturer

Thank you for buying our product. Their reliability has been confirmed in many tests. Reliability of towbar depends also on correct assembly and right operation. For this reasons we kindly ask to read carefully this instruction and apply to hints.

*The towbar should be install in points described by a car producer.*

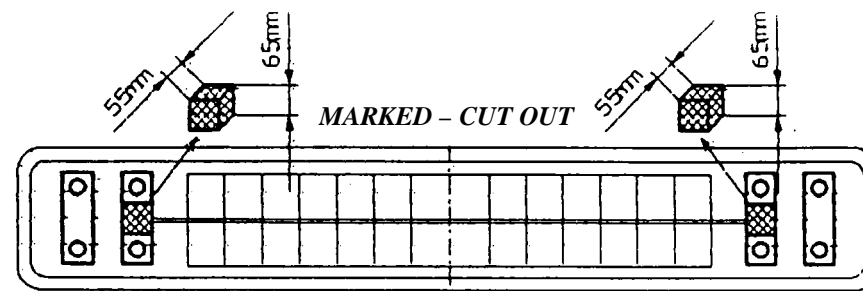

### The instruction of the assembly

1. Disassemble bumper and cover panels inside the trunk.
2. The bumper disassemble to components.
3. From inside of the bumper disassemble brackets (not used any more). Cut out fragments in the bar as shown on the figure.
4. Inside trunk, on the left and right side remove rubber face veneer (in places where will be fish-plates pos. 4 and 5). Next put this fish-plates (base holes-A). Next mark holes pos. B and C, drill it using bit  $\phi 1$ mm.
5. Through holes pos. D fix main bar of the towbar (pos. 1) using bolts M8x25mm (pos. 11) with inside part of the bumper. In this way prepared unit put to the chassis members.
6. In the trunk put fish-plates (pos. 4 and 5) and washer. Underneath put distance sleeves (pos. 6) and fix through holes using bolts from equipment as shown on the figure
7. Fix body of the automat (pos. 15) and the socket plate (pos. 3) using bolts M12x25mm (pos. 7) from accessories. Place tow-ball (pos. 2) according to supplied instruction.
8. Fix tight all bolts according to the torque shown in the table.
9. Connect electric wires of 7-poles socket according to the instruction of the car. (Recommend to make at authorized service station)
10. Complete paint layer damaged during installation.

#### Torque settings for nuts and bolts (8,8):

<b>M6</b> - 11 Nm	<b>M8</b> - 25 Nm	<b>M10</b> - 50 Nm
<b>M12</b> - 87 Nm	<b>M14</b> - 138 Nm	<b>M16</b> - 210 Nm











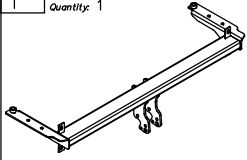







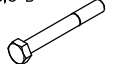

#### NOTE

After install the towbar you should get adequate note in registration book (at authorised service station).The car should be equipped with:

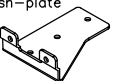
- Indicators
- Tow mirrors

After 1000km of exploitation check all bolts and nuts. The ball of towbar must be always kept clear and conserve with a grease.

## Towbar equipment:

Pos. 1 Name: Main bar Quantity: 1 	Pos. 6 Name: Distance sleeve Quantity: 2 Dim.: Ø17,2x2,35mm L=35mm 	Pos. 12 Name: Washer Quantity: 2 Dim.: Ø35xØ12x6mm 	Pos. 18 Name: Plain washer Quantity: 4 Dim.: Ø 13 mm 
Pos. 2 Name: Tow ball Quantity: 1 	Pos. 7 Name: Bolt 8,8 B Quantity: 4 Dim.: M12x25mm 	Pos. 13 Name: Washer Quantity: 2 Dim.: Ø35xØ12x3mm 	Pos. 19 Name: Plain washer Quantity: 8 Dim.: Ø 10,5 mm 
Pos. 3 Name: Socket plate Quantity: 1 	Pos. 8 Name: Bolt 8,8 B Quantity: 2 Dim.: M10x90mm 	Pos. 14 Name: Washer Quantity: 8 Dim.: Ø25xØ9x3mm 	Pos. 20 Name: Spring washer Quantity: 4 Dim.: Ø 12,2 mm 
Pos. 4 Name: Right fish-plate Quantity: 1 	Pos. 9 Name: Bolt 8,8 B Quantity: 4 Dim.: M10x50mm 	Pos. 15 Name: Body of the automat Quantity: 1 	Pos. 21 Name: Spring washer Quantity: 10 Dim.: Ø 10,2 mm 
Pos. 5 Name: Left fish-plate Quantity: 1 	Pos. 10 Name: Bolt 8,8 B Quantity: 4 Dim.: M10x35mm 	Pos. 16 Name: Nut 8 B Quantity: 6 Dim.: M10 	Pos. 22 Name: Ball cover Quantity: 1 
	Pos. 11 Name: Bolt 8,8 B Quantity: 4 Dim.: M8x25mm 	Pos. 17 Name: Nut 8 B Quantity: 4 Dim.: M8 	Pos. 23 Name: Body plug Quantity: 1 



**PPUH AUTO-HAK S. J.**

Produkcja Zaczepów Kulowych  
Henryk & Zbigniew Nejman  
76-200 SŁUPSK ul. Słoneczna 16K  
tel/fax (059) 8-414-414; 8-414-413  
E-mail: [office@autohak.com.pl](mailto:office@autohak.com.pl)  
[www.autohak.com.pl](http://www.autohak.com.pl)

## Towing hitch (without electrical set)

Class: **A50-X** Cat. no. **X10A**

Designed for:

Manufacturer: **DAEWOO**

Model: **LEGANZA**

Type: **4 door**

produced since 1997 till 2003

Technical data:

**D-value: 8,1 N**

maximum trailer weight: **1500 kg**

maximum vertical cup load: **75 kg**

Approval number according to Directive 94/20/EC: **e20\*94/20\*0591\*00**

## Foreword

This towbar is designed according to rules of safety traffic regulations. The towing hitch is a safety component and can be install only by qualified personnel. Any alteration or conversion of the towing hitch is prohibited and would lead to cancellation of design certification. Remove insulating compound and underseal from vehicle (if present) in the area of the matting surfaces of the towing hitch. The vehicle manufacturer's specifications regarding trailer load and max. vertical cup load are decisive for driving whereat values for the towing hitch cannot be exceeded.

*D-value formula:*

$$\frac{\text{Max trailer weight [kg]} \times \text{Max vehicle weight [kg]}}{\text{Max trailer weight [kg]} + \text{Max vehicle weight [kg]}} \times \frac{9,81}{1000} = D \text{ [kN]}$$