

## FITTING INSTRUCTION

Clamp mark in acc. with		Cables joining
ISO	PN	
1	L	Left directional lights
2	+	Rear fog lights
3	31	Ground
4	R	Right directional lights
5	58R	Right side parking lights
6	54	Stoplights
7	58L	Left side parking lights

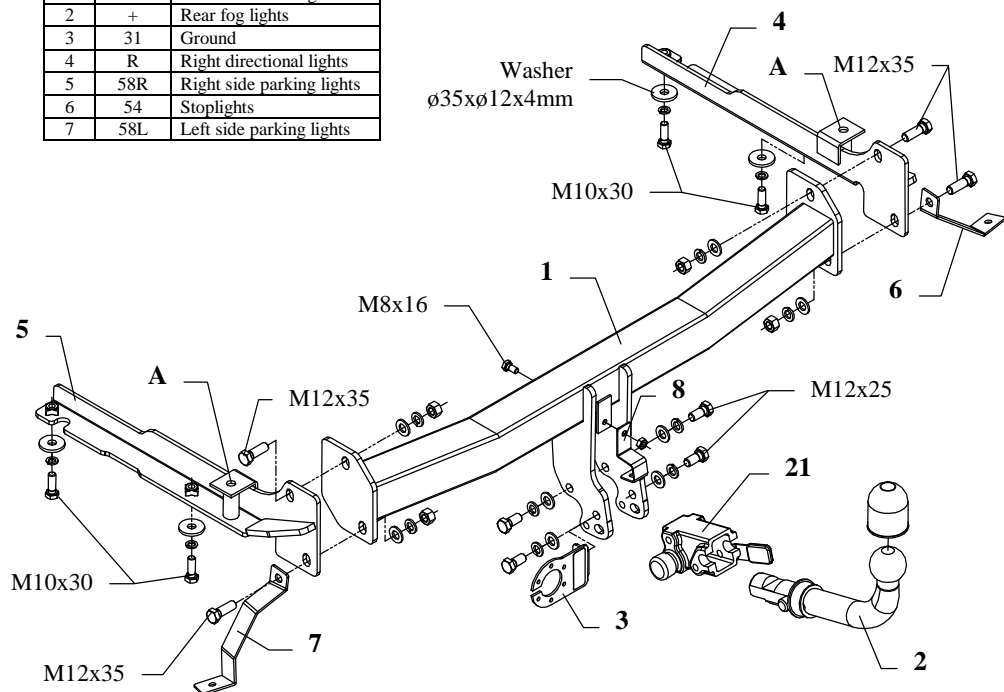

This towbar is designed to assembly in following cars:  
**DAEWOO NUBIRA II, 4 door**, produced since 07.1999 till 2003,  
 catalogue no. **X11A** and is prepared to tow trailers max total weight  
**1200 kg** and max vertical load **70 kg**.

### *From manufacturer*

Thank you for buying our product. Their reliability has been confirmed in many tests. Reliability of towbar depends also on correct assembly and right operation. For this reasons we kindly ask to read carefully this instruction and apply to hints.

*The towbar should be installing in points described by a car producer.*

## The instruction of the assembly

1. Take off the bumper and then the metal canopy of fastening the bumper and its soft fulfillment. Both these parts will not be fastened again.
2. Unscrew the filter of the activated carbon from the right side of the car (protect before the damage).
3. Put side brackets (pos. 4 and 5) into chassis members and fix using bolts M10x30mm (pos. 12). Use washers (pos. 9) from the towbar accessories.
4. Through holes (pos. A) fix using bolts M10x100mm remaining after disassembling unscrewing of the metal canopy.
5. Through two distance sleeves L=10mm (pos. 14) from the towbar accessories fix previously unscrewed filter of the activated carbon.
6. To installed brackets (pos. 4 and 5) fix the main bar of the towbar (pos. 1) using bolts M12x35mm (pos. 11).
7. Fix handles (pos. 6, 7 and 8) to the main bar of the towbar (pos. 1), as shown on the drawing.
8. Fix the bumper (use handles of the towbar).
9. Fix body of the automat (pos. 21) and the socket plate (pos. 3) using bolts M12x25mm (pos. 10) from accessories. Place tow-ball (pos. 2) according to supplied instruction.
10. Tighten all bolts according to the torque shown in the table.
11. Connect electric wires of 7-poles socket according to the instruction of the car. (Recommend to make at authorized service station).
12. Complete paint layer damaged during installation.

Torque settings for nuts and bolts (8,8):	
<b>M 8</b> - 25 Nm	<b>M 10</b> - 55 Nm
<b>M 12</b> - 85 Nm	<b>M 14</b> - 135 Nm











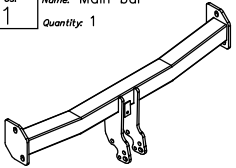
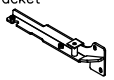

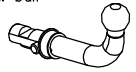



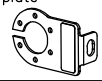

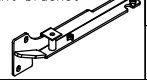

### NOTE

After install the towbar you should get adequate note in registration book (at authorised service station).The car should be equipped with:

- Indicators
- Tow mirrors

Check all bolts after 1000km of exploitation. The ball of towbar must be always kept clear and conserve with a grease.

## Towbar accessories:

Pos. 1 Name: Main bar Quantity: 1 	Pos. 5 Name: Left bracket Quantity: 1 	Pos. 11 Name: Bolt 8,8 B Quantity: 4 Dim.: M12x35mm 	Pos. 17 Name: Plain washer Quantity: 8 Dim.: Ø 13 mm 
Pos. 2 Name: Tow ball Quantity: 1 	Pos. 6 Name: Right handle of bumper Quantity: 1 	Pos. 12 Name: Bolt 8,8 B Quantity: 4 Dim.: M10x30mm 	Pos. 18 Name: Spring washer Quantity: 8 Dim.: Ø 12,2 mm 
Pos. 3 Name: Socket plate Quantity: 1 	Pos. 7 Name: Left handle of bumper Quantity: 1 	Pos. 13 Name: Bolt 8,8 B Quantity: 1 Dim.: M8x16mm 	Pos. 19 Name: Spring washer Quantity: 4 Dim.: Ø 10,2 mm 
Pos. 4 Name: Right bracket Quantity: 1 	Pos. 8 Name: Middle handle of bumper Quantity: 1 	Pos. 14 Name: Distance sleeve Quantity: 2 Dim.: Ø21xØ15mm L=10mm 	Pos. 20 Name: Ball cover Quantity: 1 
Pos. 9 Name: Washer Quantity: 4 Dim.: Ø35xØ12x4mm 	Pos. 15 Name: Nut 8 B Quantity: 4 Dim.: M12 	Pos. 21 Name: Body of the automat Quantity: 1 	Pos. 10 Name: Bolt 8,8 B Quantity: 4 Dim.: M12x25mm 
	Pos. 16 Name: Nut 8 B Quantity: 1 Dim.: M8 	Pos. 22 Name: Body plug Quantity: 1 	



**PPUH AUTO-HAK S.J.**

Produkcja Zaczepów Kulowych  
Henryk & Zbigniew Nejman  
76-200 SŁUPSK ul. Słoneczna 16K  
tel/fax (059) 8-414-414; 8-414-413  
E-mail: [office@autohak.com.pl](mailto:office@autohak.com.pl)  
[www.autohak.com.pl](http://www.autohak.com.pl)

## Towing hitch (without electrical set)

Class: **A50-X** Cat. no. **X11A**

Designed for:

Manufacturer: **DAEWOO**

Model: **NUBIRA II**

Typ: **4 door**

produced since 07.1999 till 2003

Technical data:

**D-value: 7,00 kN**

maximum trailer weight: **1200 kg**

maximum vertical cup load: **70 kg**

Approval number according to Directive 94/20/EC: **e20\*94/20\*0635\*00**

## Foreword

This towbar is designed according to rules of safety traffic regulations. The towing hitch is a safety component and can be installed only by qualified personnel. Any alteration or conversion of the towing hitch is prohibited and would lead to cancellation of design certification. Remove insulating compound and underseal from vehicle (if present) in the area of the mating surfaces of the towing hitch.

The vehicle manufacturer's specifications regarding trailer load and max. vertical cup load are decisive for driving whereat values for the towing hitch cannot be exceeded.

*D-value formula:*

$$\frac{\text{Max trailer weight [kg]} \times \text{Max vehicle weight [kg]}}{\text{Max trailer weight [kg]} + \text{Max vehicle weight [kg]}} \times \frac{9,81}{1000} = D \text{ [kN]}$$