

## FITTING INSTRUCTION

Clamp mark in acc. with		Cables joining
ISO	PN	
1	L	Left directional lights
2	+	Rear fog lights
3	31	Ground
4	R	Right directional lights
5	58R	Right side parking lights
6	54	Stoptlights
7	58L	Left side parking lights

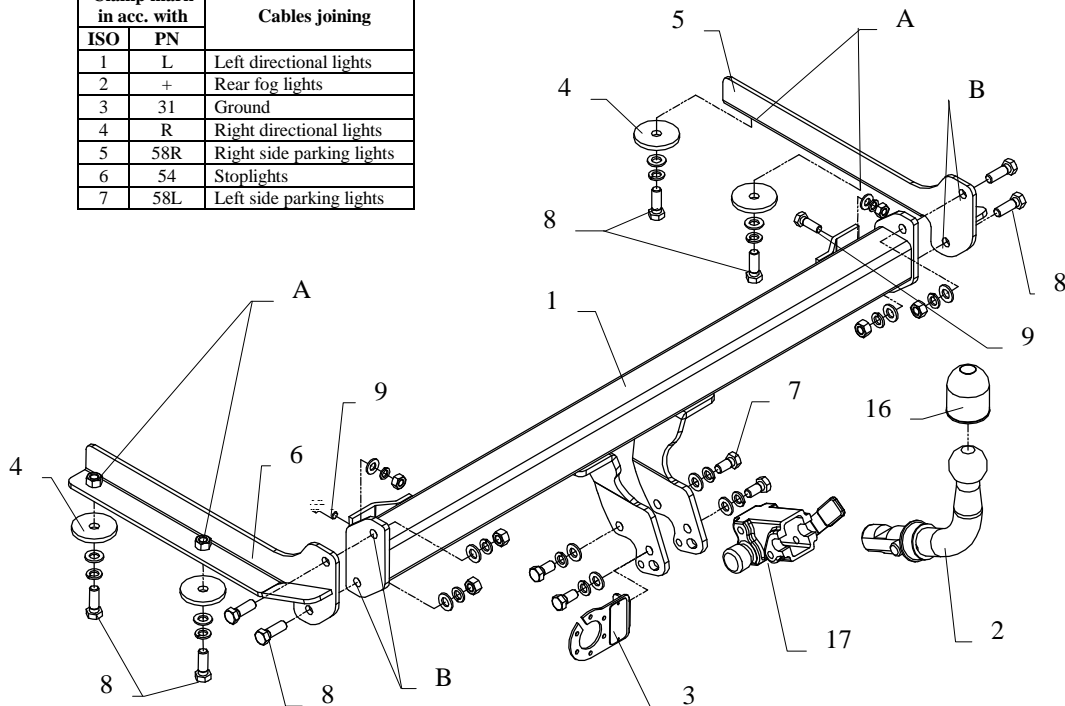

This towbar is designed to assembly in following cars:  
**HONDA CIVIC 5 doors**, produced since 04.1995 till 03.1997, catalogue no. **Y02A** and is prepared to tow trailers max total weight **1200kg** and max vertical load **50kg**.

### *From manufacturer*

Thank you for buying our product. Their reliability has been confirmed in many tests. Reliability of towbar depends also on correct assembly and correct exploitation. For this reasons we kindly ask to read carefully this instruction and apply to hints.

*The towbar should be install in points described by a car producer.*

## Assemble instruction

1. Disassemble the bumper. Untwist two plugs in chassis members (in rear part of the car).
2. Put side brackets (pos. 5 and 6) and fix loosely using bolts M12x35mm (pos. 8) - in points A, through washers (pos. 4) and original holes in chassis members.
3. Fix main bar of the towbar (pos. 1) to installed brackets using bolts M12x35mm (pos. 8) through holes B.
4. Through original holes in rear slice and holes in the towbar construction fix bolts M10x30mm (pos. 9)
5. Reassemble the bumper after cut out its fragment according to figure 2.
6. Fix body of the automat (pos. 17) and the socket plate (pos. 3) using bolts M12x25mm (pos. 7) from accessories. Place tow-ball (pos. 2) according to supplied instruction.
7. Tighten all bolts according to the torque shown in the table.
8. Connect electric wires of 7-poles socket according to the instruction of the car. (Recommend to make at authorized service station)
9. Complete paint layer damaged during installation.

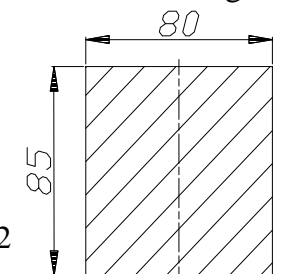

Fig. 2

Torque settings for nuts and bolts (8,8):

<b>M 8</b>	25 Nm	<b>M 10</b>	55 Nm
<b>M 12</b>	85 Nm	<b>M 14</b>	135 Nm











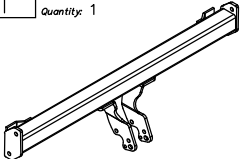
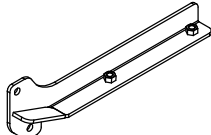



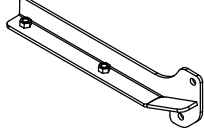

### NOTE

After install the towbar you should get adequate note in registration book (at authorised service station).The car should be equipped with:

- Indicators
- Tow mirrors

After 1000km check all bolts. The ball of towbar must be always kept clear and conserve with a grease.

## Towbar accessories:

Pos. 1 Name: Main bar Quantity: 1 	Pos. 5 Name: Right bracket Quantity: 1 	Pos. 8 Name: Bolt 8,8 B Quantity: 8 Dim.: M12x35mm 	Pos. 13 Name: Plain washer Quantity: 4 Dim.: Ø 10,5 mm 
Pos. 2 Name: Tow ball Quantity: 1 	Pos. 6 Name: Left bracket Quantity: 1 	Pos. 9 Name: Bolt 8,8 B Quantity: 4 Dim.: M10x30mm 	Pos. 14 Name: Spring washer Quantity: 12 Dim.: Ø 12,2 mm 
Pos. 3 Name: Socket plate Quantity: 1 		Pos. 10 Name: Nut 8 B Quantity: 4 Dim.: M12 	Pos. 15 Name: Spring washer Quantity: 4 Dim.: Ø 10,2 mm 
Pos. 4 Name: Washer Quantity: 4 Dim.: Ø58xØ12x6mm 		Pos. 11 Name: Nut 8 B Quantity: 4 Dim.: M10 	Pos. 16 Name: Ball cover Quantity: 1 
Pos. 7 Name: Bolt 8,8 B Quantity: 4 Dim.: M12x25mm 	Pos. 12 Name: Plain washer Quantity: 12 Dim.: Ø 13 mm 	Pos. 17 Name: Body of the automat Quantity: 1 	
	Pos. 18 Name: Body plug Quantity: 1 		



**PPUH AUTO-HAK S.J.**

Produkcja Haków Holowniczych  
Henryk & Zbigniew Nejman  
76-200 SŁUPSK ul. Słoneczna 16K  
tel/fax (059) 8-414-414; 8-414-413  
E-mail: office@autohak.com.pl  
www.autohak.com.pl

## Towing hitch (without electrical set)

Class: **A50-X** Cat. no. **Y02A**

Designed for:

Manufacturer: **HONDA**

Model: **CIVIC**

Type: **5 doors**

produced since 04.1997 till 03.1997

Technical data:

**D-value: 6,93 kg**

maximum trailer weight: **1200 kg**

maximum vertical cup load: **50 kg**

**Approval number acc. to regulations EKG/ONZ 55.01: E20-55R-01 1775**

## Foreword

This towbar is designed according to rules of safety traffic regulations. The towing hitch is a safety component and can be install only by qualified personnel. Any alteration or conversion of the towing hitch is prohibited and would lead to cancellation of design certification. Remove insulating compound and underseal from vehicle (if present) in the area of the matting surfaces of the towing hitch. The vehicle manufacturer's specifications regarding trailer load and max. vertical cup load are decisive for driving, and values for the towing hitch cannot be exceeded.

*D-value formula:*

$$\frac{\text{Max trailer weight [kg]} \times \text{Max vehicle weight [kg]}}{\text{Max trailer weight [kg]} + \text{Max vehicle weight [kg]}} \times \frac{9,81}{1000} = D \text{ [kN]}$$