

## FITTING INSTRUCTION

Clamp mark in acc. with		Cables joining
ISO	PN	
1	L	Left directional lights
2	+	Rear fog lights
3	31	Ground
4	R	Right directional lights
5	58R	Right side parking lights
6	54	Stoplights
7	58L	Left side parking lights

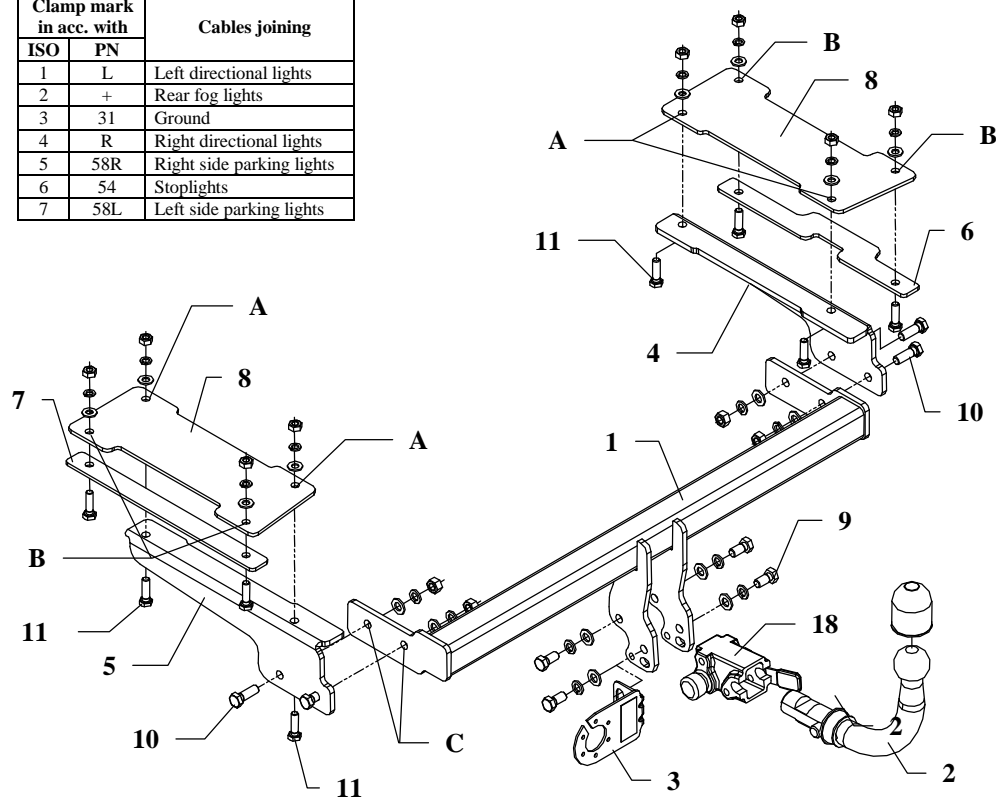

This towbar is designed to assembly in following cars:

**HONDA CIVIC 4 door**, catalogue no. **Y10A**, produced since 1996 till 1998 and is prepared to tow trailers max total weight **1300 kg** and max vertical load **50 kg**.

### From manufacturer

Thank you for buying our product. Their reliability has been confirmed in many tests. Reliability of towbar depends also on correct assembly and right operation. For this reasons we kindly ask to read carefully this instruction and apply to hints.

*The towbar should be install in points described by a car producer.*

## The instruction of the assembly

1. Disassemble rear bumper and covers inside trunk.
2. Underneath the car mark points according to figure 1. Next drill holes using bit  $\phi 11$ mm, make very carefully.
3. Inside the trunk put suitable upper fish-plates (pos.8).
4. Underneath the car put side brackets (pos. 4 and 5) and through holes (pos. A) and fish-plates (pos. 8) fix using bolts M10x35mm (pos. 11).
5. Underneath the car put fish-plates (pos. 6 and 7), next through holes (pos. B) and fish-plates (pos. 8) fix using bolts M10x35mm (pos. 11) .
6. Through holes (pos. C) fix main bar of the towbar (pos. 1) with side brackets using bolts M12x35mm (pos. 10).
7. Fix tight all bolts according to the torque shown in the table.
8. Reassemble bumper and covers inside trunk.
9. Fix body of the automat (pos. 18) and the socket plate (pos. 3) using bolts M12x25mm (pos. 9) from accessories. Place tow-ball (pos. 2) according to supplied instruction.
10. Connect electric wires of 7-poles socket according to the instruction of the car. (Recommend to make at authorized service station)
11. Complete paint layer damaged during installation.

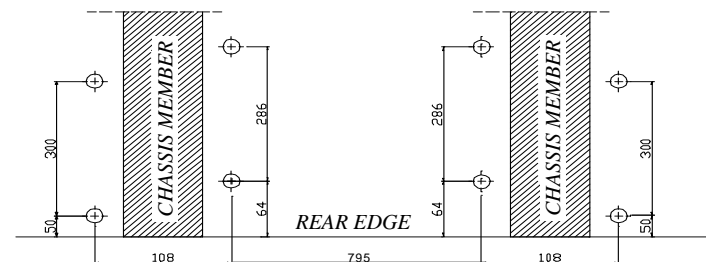

Fig. 1. Underneath view after bumper disassembly.

Torque settings for nuts and bolts (8,8):	
<b>M 8 - 25 Nm</b>	<b>M 10 - 55 Nm</b>
<b>M 12 - 85 Nm</b>	<b>M 14 - 135 Nm</b>











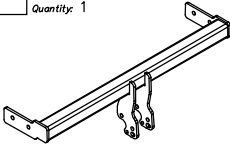
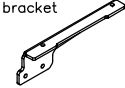

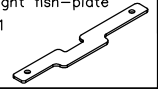
### NOTE

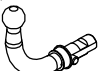
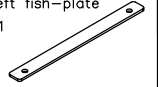
After install the towbar you should get adequate note in registration book (at authorised service station).The car should be equipped with:

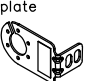
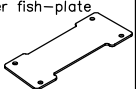
- Indicators
- Tow mirrors

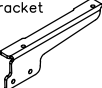
After 1000km check all bolts and nuts. The ball of towbar must be always kept clear and conserve with a grease.

## Towbar accessories:

Pos. 1 Name: Main bar Quantity: 1 	Pos. 5 Name: Left bracket Quantity: 1 	Pos. 10 Name: Bolt 8,8 B Quantity: 4 Dim.: M12x35mm 	Pos. 15 Name: Plain washer Quantity: 8 Dim.: Ø 10,5 mm 
	Pos. 6 Name: Right fish-plate Quantity: 1 	Pos. 11 Name: Bolt 8,8 B Quantity: 8 Dim.: M10x35mm 	Pos. 16 Name: Spring washer Quantity: 8 Dim.: Ø 12,2 mm 
Pos. 2 Name: Tow ball Quantity: 1 	Pos. 7 Name: Left fish-plate Quantity: 1 	Pos. 12 Name: Nut 8 B Quantity: 4 Dim.: M12 	Pos. 17 Name: Spring washer Quantity: 8 Dim.: Ø 10,2 mm 
Pos. 3 Name: Socket plate Quantity: 1 	Pos. 8 Name: Upper fish-plate Quantity: 2 	Pos. 13 Name: Nut 8 B Quantity: 8 Dim.: M10 	Pos. 18 Name: Body of the automat Quantity: 1 
Pos. 4 Name: Right bracket Quantity: 1 	Pos. 9 Name: Bolt 8,8 B Quantity: 4 Dim.: M12x25mm 	Pos. 14 Name: Plain washer Quantity: 8 Dim.: Ø 13 mm 	Pos. 19 Name: Body plug Quantity: 1 
			Pos. 20 Name: Ball cover Quantity: 1 



**PPUH AUTO-HAK S.J.**

Produkcja Haków Holowniczych  
Henryk & Zbigniew Nejman  
76-200 SŁUPSK ul. Słoneczna 16K  
tel/fax (059) 8-414-414; 8-414-413  
email: [office@autohak.com.pl](mailto:office@autohak.com.pl)  
[www.autohak.com.pl](http://www.autohak.com.pl)

## Towing hitch (without electrical set)

Class: **A50-X** Cat. no. **Y10A**

Designed for:

Manufacturer: **HONDA**

Model: **CIVIC**

Type: **4 door**

produced since 1996 till 1998

Technical data:

**D-value: 6,07 kN**

maximum trailer weight: **1300 kg**

maximum vertical cup load: **50 kg**

**Approval number according to Directive 94/20/EC: e20\*94/20\*0500\*00**

## Foreword

This towbar is designed according to rules of safety traffic regulations. The towing hitch is a safety component and can be install only by qualified personnel. Any alteration or conversion of the towing hitch is prohibited and would lead to cancellation of design certification. Remove insulating compound and underseal from vehicle (if present) in the area of the matting surfaces of the towing hitch.

The vehicle manufacturer's specifications regarding trailer load and max. vertical cup load are decisive for driving, and values for the towing hitch cannot be exceeded.

*D-value formula:*

$$\frac{\text{Max trailer weight [kg]} \times \text{Max vehicle weight [kg]}}{\text{Max trailer weight [kg]} + \text{Max vehicle weight [kg]}} \times \frac{9,81}{1000} = D \text{ [kN]}$$