

FITTING INSTRUCTION

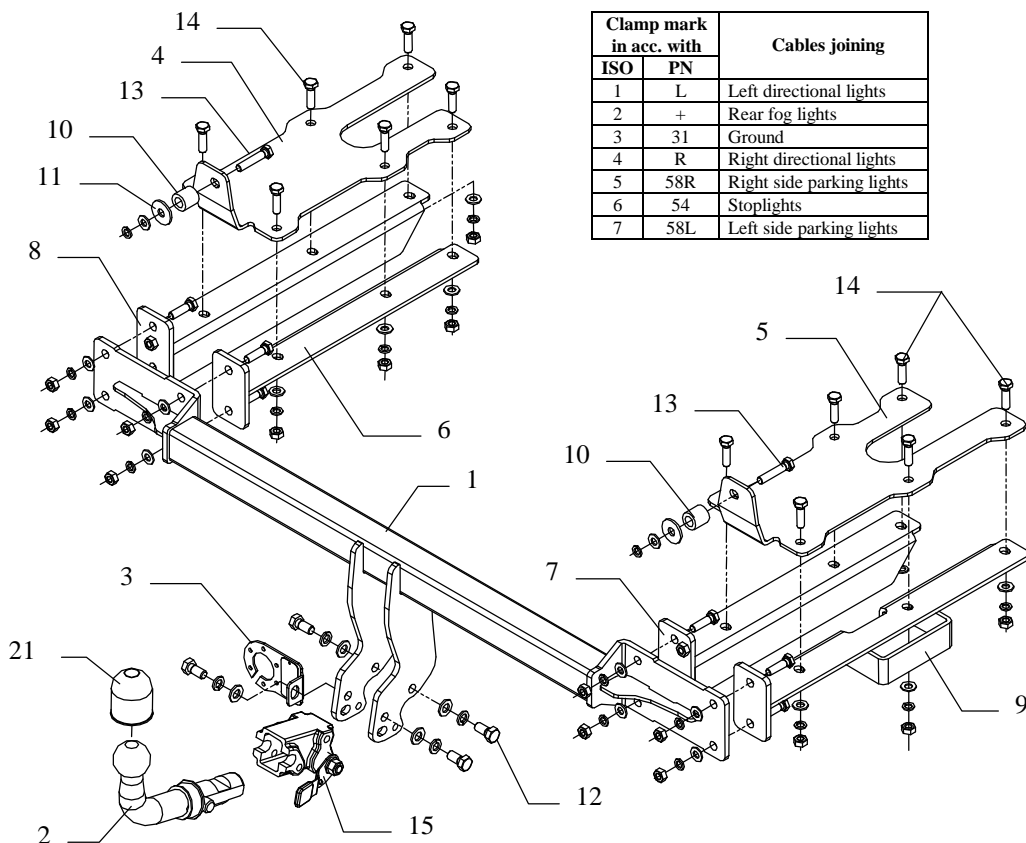

Clamp mark in acc. with		Cables joining
ISO	PN	
1	L	Left directional lights
2	+	Rear fog lights
3	31	Ground
4	R	Right directional lights
5	58R	Right side parking lights
6	54	Stoptlights
7	58L	Left side parking lights

This towing hitch is designed to assembly in following cars:
HONDA CIVIC 4 doors, catalogue no. **Y21A**, produced since 11.2000 till 03.2006 and is prepared to tow trailers max total weight **1200 kg** and max vertical load **50 kg**.

The towing hitch should be install in points described by a car producer. Fitting points are described in instruction of the car, see page 400.

Torque settings for nuts and bolts (8,8):

M8	25 Nm	M10	55 Nm
M12	85 Nm	M14	135 Nm

Fig. 2

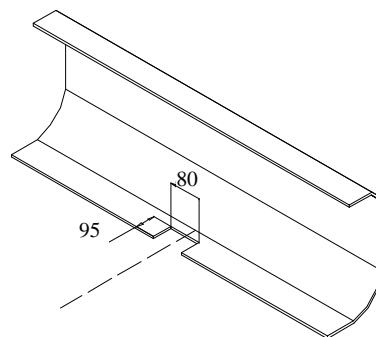
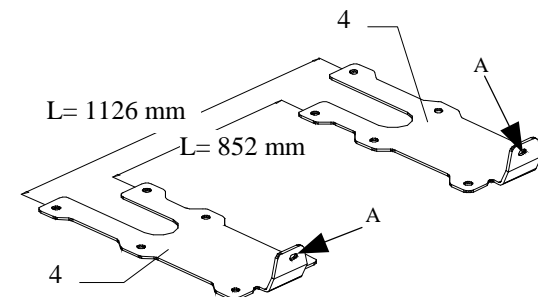

Fig. 3



Fitting instructions

1. Disassemble the bumper and covers in the trunk – side covers and rear plate covers.
2. Cut out fragment of the bumper in bottom part, see fig. 2.
3. To factory prepared holes in rear part slip sleeves $\varnothing 25 \times \varnothing 15$, $L=25$ (pos. 10).
4. To the trunk put plates (pos. 4 and 5) in this way so holes A tally with holes with sleeves, see fig. 3.
5. Through rest of holes mark points. Take out plates and remove anti noise mass. Under mass layer are original marked holes. Drill this holes using bit $\varnothing 11$ mm.
6. Put plates again to the trunk, put bolts M10x35mm (pos. 14) to all drilled holes and bolts M10x50mm (pos. 13) through holes A, see fig. 3. On protruding bolts from below the car put adequately brackets (pos. 6, 7, 8, 9) as shown in the drawing and fix loosely.
7. To in this way prepared brackets (pos. 6, 7, 8, 9) fix main bar of the towing hitch (pos. 1) using bolts M10x35mm (pos. 14).
8. Tighten all bolts according to the torque shown in the table.
9. Assemble the bumper.
10. Fix body of the automat (pos. 15) and the socket plate (pos. 3) using bolts M12x25mm (pos. 12) from accessories. Place tow-ball (pos. 2) according to supplied instruction.
11. Connect electric wires of 7-poles socket according to the instruction of the car. (Recommend to make at authorized service station)
12. Complete paint layer damaged during installation.











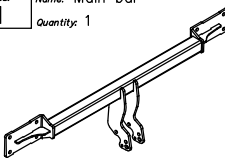
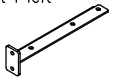

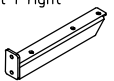

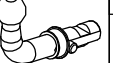

NOTE

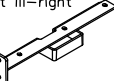
After install the towing hitch you should get adequate note in registration book (at authorised service station).The car should be equipped with:

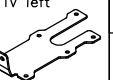
- Indicators
- Tow mirrors

After 1000km check all bolts. The ball of towing hitch must be always kept clear and conserve with a grease.

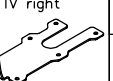
Towing hitch accessories:

Pos. 1 Name: Main bar Quantity: 1 	Pos. 6 Name: Bracket I left Quantity: 1 Dim.: 438x100x60 	Pos. 12 Name: Bolt 8,8 B Quantity: 4 Dim.: M12x25mm 	Pos. 18 Name: Plain washer Quantity: 22 Dim.: Ø 10,5 mm 
	Pos. 7 Name: Bracket I right Quantity: 1 Dim.: 438x100x60 	Pos. 13 Name: Bolt 8,8 B Quantity: 2 Dim.: M10x50mm 	Pos. 19 Name: Spring washer Quantity: 4 Dim.: Ø 12,2 mm 
Pos. 2 Name: Tow ball Quantity: 1 	Pos. 8 Name: Bracket II-left Quantity: 1 Dim.: 494x100x60 	Pos. 14 Name: Bolt 8,8 B Quantity: 20 Dim.: M10x35mm 	Pos. 20 Name: Spring washer Quantity: 22 Dim.: Ø 10,2 mm 
Pos. 3 Name: Socket plate Quantity: 1 	Pos. 9 Name: Bracket III-right Quantity: 1 Dim.: 494x100x60 	Pos. 15 Name: Body of the automat Quantity: 1 	Pos. 21 Name: Ball cover Quantity: 1 
Pos. 4 Name: Bracket IV left Quantity: 1 Dim.: 45x180x90 	Pos. 10 Name: Sleeve Quantity: 1 Dim.: Ø25xØ15x25 	Pos. 16 Name: Nut 8 B Quantity: 22 Dim.: M10 	Pos. 22 Name: Body plug Quantity: 1 
Pos. 5 Name: Bracket IV right Quantity: 1 Dim.: 45x180x90 	Pos. 11 Name: Washer Quantity: 1 Dim.: 355x12x3 	Pos. 17 Name: Plain washer Quantity: 4 Dim.: Ø 13 mm 	



PPUH AUTO-HAK S.J.

Produkcja Haków Holowniczych
Henryk & Zbigniew Nejman
76-200 SŁUPSK ul. Słoneczna 16K
tel/fax (059) 8-414-414; 8-414-413
e-mail: office@autohak.com.pl
www.autohak.com.pl

Towing hitch (without electrical set)

Class: **A50-X** Cat. no. **Y21A**

Designed for:

Manufacturer: **HONDA**

Model: **CIVIC**

Type: **4 doors**

produced since 11.2000 till 03.2006

Technical data:

D-value: 6,69 kN

maximum trailer weight: **1200 kg**

maximum vertical cup load: **50 kg**

Approval number according to Directive 94/20/EC: **e20*94/20*0103*00**

Foreword

This towing hitch is designed according to rules of safety traffic regulations. The towing hitch is a safety component and must be installed only by qualified personnel. Any alteration or conversion to the towinh hitch is prohibited and would lead to cancellation of design certification. Remove insulating compound and underseal from vehicle (if present) in the area of the matting surfaces of the towing hitch.

The vehicle manufacturer's specifications regarding trailer load and max. vertical cup load are decisive for driving, and values for the towing hitch cannot be exceeded.

D-value formula:

$$\frac{\text{Max trailer weight [kg]} \times \text{Max vehicle weight [kg]}}{\text{Max trailer weight [kg]} + \text{Max vehicle weight [kg]}} \times \frac{9,81}{1000} = D \text{ [kN]}$$