

FITTING INSTRUCTION

Clamp mark in acc. with		Cables joining
ISO	PN	
1	L	Left directional lights
2	+	Rear fog lights
3	31	Ground
4	R	Right directional lights
5	58R	Right side parking lights
6	54	Stoptlights
7	58L	Left side parking lights

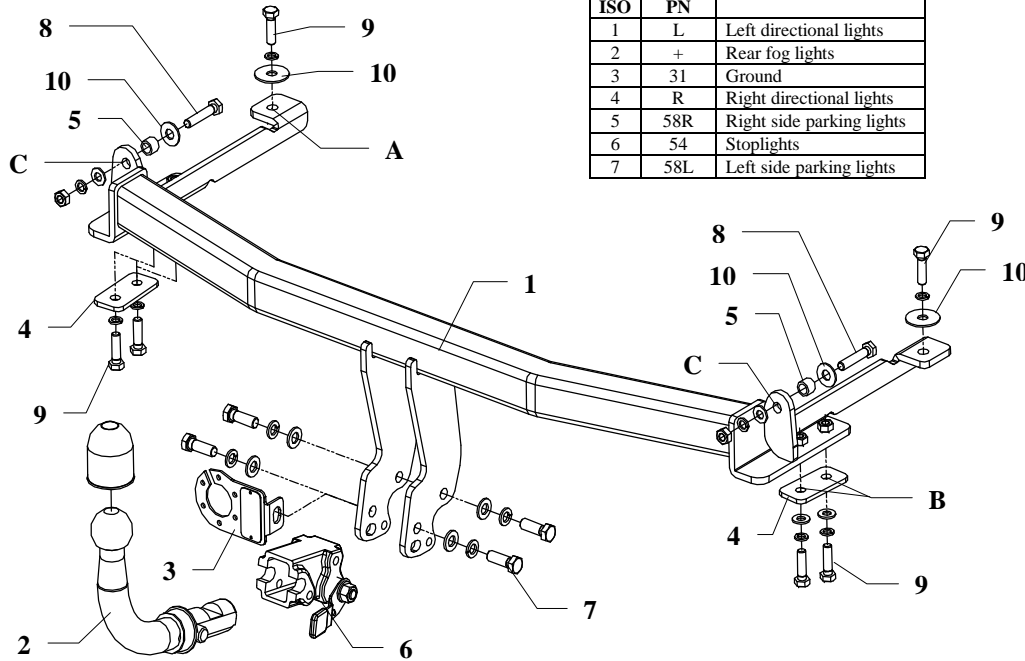

This towbar is designed to assembly in following cars: **HONDA JAZZ**, produced since 2002 till 2008, catalogue no. **Y27A** and is prepared to tow trailers max total weight up to **1000 kg** and max vertical mass **70 kg**.

From manufacturer

Thank you for buying our product. Their reliability has been confirmed in many tests. Reliability of towbar depends also on correct assembly and right operation. For this reasons we kindly ask to read carefully this instruction and apply to hints.

The towbar should be install in points described by a car producer.

The instruction of the assembly

- Disassemble:
 - the bumper
 - metal parts, which bar access to the chassis member (this part is not used any more)
 - rear and side sheet from the boot
 - plastic covers from the car floor

- Slide the element (pos. 1) to the chassis member (do it such a way the towbar holes pos. A and B cover original holes) and fix it loosely with M10x35mm bolts (pos. 9)
- Drill through the towbar holes (pos. C) using bit $\varnothing 11$ mm, position the spacers $\varnothing 17 \times 13$ mm (pos. 5) inside the boot and fix it using M10x50 bolts (pos. 8)
- Fix body of the automat (pos. 6) and the socket plate (pos. 3) using bolts M12x25mm (pos. 7) from accessories. Place tow-ball (pos. 2) according to supplied instruction.

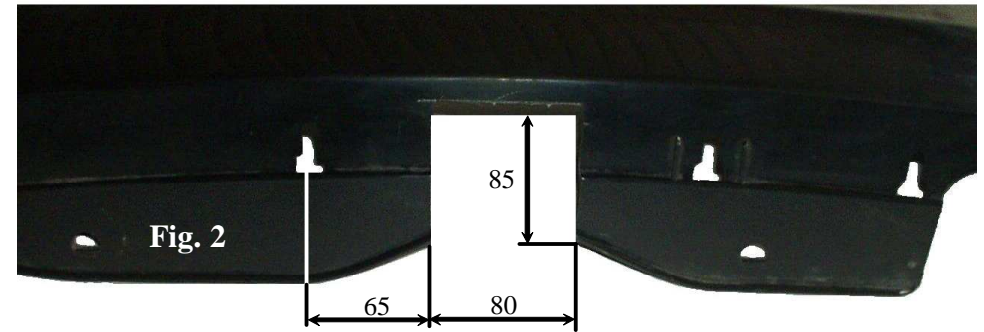

- Tighten all nuts and bolts according to the torque shown in the table
- Cut the bumper according to the fig. 2 and then reassemble it.
- Connect electric wires of 7-pole socket according to the instruction of the car. (Recommend to make at authorized service station)
- Complete paint layer damaged during installation.

Torque settings for nuts and bolts (8,8):

M6 - 11 Nm	M8 - 25 Nm	M10 - 50 Nm
M12 - 87 Nm	M14 - 138 Nm	M16 - 210 Nm











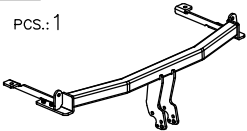





NOTE

After install the towbar you should get adequate note in registration book (at authorised service station).The car should be equipped with:

- Indicators
- Tow mirrors

Check all bolts and nuts after 1000km of exploitation. The ball of towbar must be always kept clear and conserve with a grease.

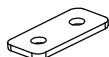
Towbar accessories:

Pos. 1 Main bar PCS.: 1 	Pos. 5 Distance sleeve ø17,2x2,35mm L=13mm PCS.: 2 	Pos. 10 Plain washer ø37xø13x3mm PCS.: 4 	Pos. 15 Nut 8 B M10 PCS.: 2 
	Pos. 6 Body of the automat pcs.: 1 	Pos. 11 Plain washer ø13mm PCS.: 4 	Pos. 16 Ball cover PCS.: 1 
Pos. 2 Tow ball PCS.: 1 	Pos. 7 Bolt 8,8 B M12x25mm PCS.: 4 	Pos. 12 Plain washer ø10,5mm PCS.: 6 	Pos. 17 Body plug PCS.: 1 
Pos. 3 Socket plate PCS.: 1 	Pos. 8 Bolt 8,8 B M10x50mm PCS.: 2 	Pos. 13 Spring washer ø12,2mm PCS.: 4 	
Pos. 4 Fish-plate PCS.: 2 	Pos. 9 Bolt 8,8 B M10x35mm PCS.: 6 	Pos. 14 Spring washer ø10,2mm PCS.: 8 	



PPUH AUTO-HAK Sp.J.

Produkcja Zaczepów Kulowych
Henryk & Zbigniew Nejman
76-200 SŁUPSK ul. Słoneczna 16K
tel/fax (059) 8-414-414; 8-414-413
E-mail: office@autohak.com.pl
www.autohak.com.pl

Towing hitch (without electrical set)

Class: **A50-X** Cat. no. **Y27A**

Designed for:

Manufacturer: **HONDA**

Model: **JAZZ**

produced since 2002 till 2008

Technical data:

D-value: 5,84 kN

maximum trailer weight: **1000 kg**

maximum vertical cup load: **70 kg**

Approval number according to Directive 94/20/EC: **e20*94/20*1013*00**

Foreword

This towbar is designed according to rules of safety traffic regulations. The towing hitch is a safety component and can be install only by qualified personnel. Any alteration or conversion of the towing hitch is prohibited and would lead to cancellation of design certification. Remove insulating compound and underseal from vehicle (if present) in the area of the matting surfaces of the towing hitch.

The vehicle manufacturer's specifications regarding trailer load and max. vertical cup load are decisive for driving whereat values for the towing hitch cannot be exceeded.

D-value formula:

$$\frac{\text{Max trailer weight [kg]} \times \text{Max vehicle weight [kg]}}{\text{Max trailer weight [kg]} + \text{Max vehicle weight [kg]}} \times \frac{9,81}{1000} = D \text{ [kN]}$$