

FITTING INSTRUCTION

Clamp mark in acc. with		Cables joining
ISO	PN	
1	L	Left directional lights
2	+	Rear fog lights
3	31	Ground
4	R	Right directional lights
5	58R	Right side parking lights
6	54	Stoplights
7	58L	Left side parking lights

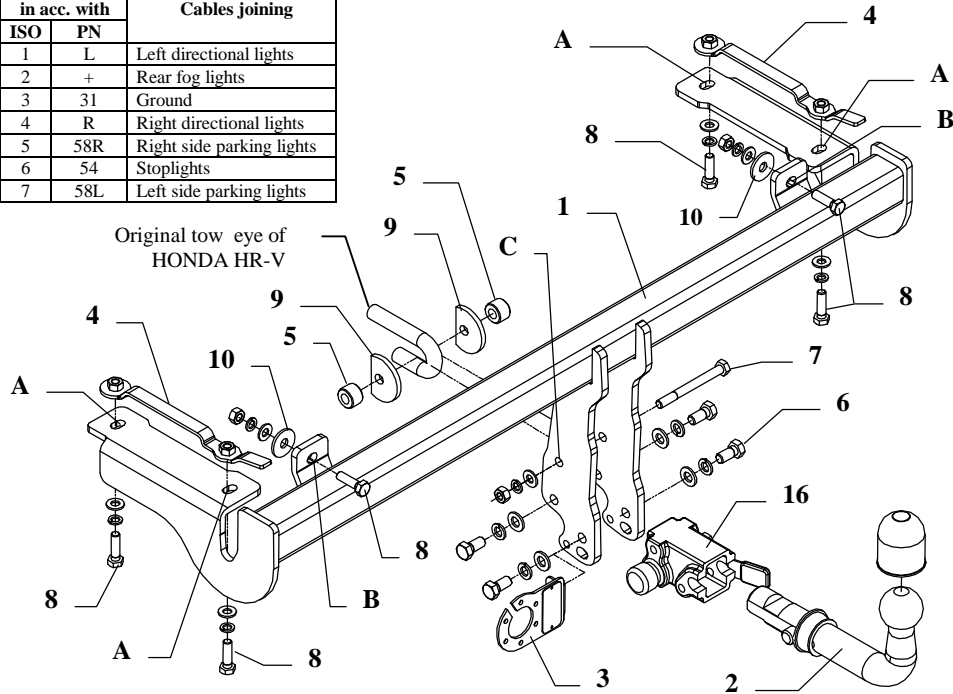

This towbar is designed to assembly in following car:

HONDA HR-V 3/5 doors, produced since 06.2002 till 2006, catalogue number **Y29A** and is prepared to tow trailers max total weight **1200 kg** and max vertical load **60 kg**.

Foreword

Thank you for buying our product. This towbar is design according to rules of safety traffic regulations and their reliability has been confirmed in many tests. Reliability of towbar also depends on correct assembly and correct exploitation. For this reasons we kindly ask to read carefully this instruction and apply to hints. *The towbar should be install in places described by a car producer.*

Fitting instructions

1. To assemble the towbar necessary is to disassemble the bumper and plastic cover below the car.
2. Unscrew rear small bumpers from rear piece of the car.
3. In rear piece make holes according to fig. 2.
4. In made holes put fish-plates with nuts (pos. 4).

5. To chassis members put main bar (pos. 1) and fix it using bolts M10x35mm (pos. 8) with fish-plates (pos. 4) through holes pos. A.
6. Through towbar holes (pos. B) and holes in rear part of the car fix main bar using bolts M10x35mm (pos. 8) and big circle washers (pos. 10).
7. Reassemble the bumper (early cut out his fragment – see fig. 3).

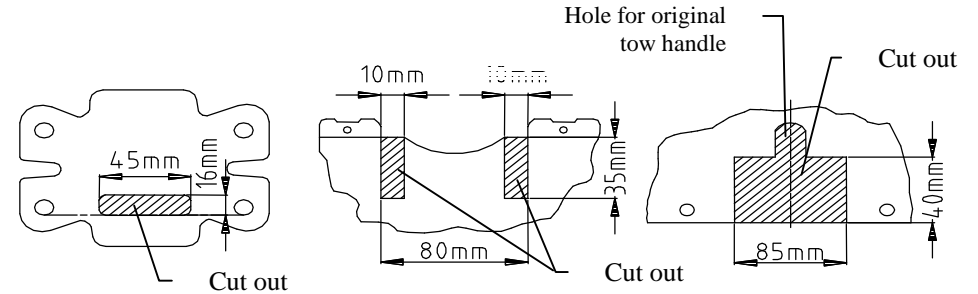

Fig.2

Fig.3

Fig.4

8. Reassemble the plastic cover (early cut out his fragment – see fig. 4).
9. Through towbar holes (pos. C) and original tow handle fix using bolt M10x75mm (pos. 7) and truncate washers (pos. 9).
10. Fix body of the automat (pos. 16) and the socket plate (pos. 3) using bolts M12x25mm (pos. 6) from accessories. Place tow-ball (pos. 2) according to supplied instruction.
11. Screw tight all bolts according to the torque shown in the table.
12. Connect electric wires according to the instruction of the car. (Recommend to make at authorized service station)
13. Supplement the paint coating damaged during assembly.

Torque settings for nuts and bolts (8,8):

M6 - 11 Nm	M8 - 25 Nm	M10 - 50 Nm
M12 - 87 Nm	M14 - 138 Nm	M16 - 210 Nm











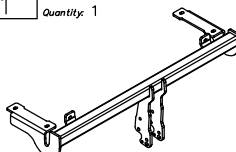



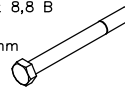

NOTE

After install the towbar you should get adequate registration in registration book (at authorised service station).The car should be equipment with:

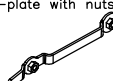
- Indicators
- Tow mirrors

After 1000km of exploitation check all bolts and nuts. The ball of towbar must be always kept clear and conserve with a grease.

Towbar accessories:

Pos. 1 Name: Main bar Quantity: 1 	Pos. 5 Name: Distance sleeve Quantity: 2 Dim.: $\varnothing 25 \times \varnothing 13 \text{mm}$ L=17mm 	Pos. 10 Name: Washer Quantity: 2 Dim.: $\varnothing 35 \times \varnothing 12 \times 3 \text{mm}$ 	Pos. 15 Name: Spring washer Quantity: 7 Dim.: $\varnothing 10,2 \text{ mm}$ 
Pos. 2 Name: Tow ball Quantity: 1 	Pos. 6 Name: Bolt 8,8 B Quantity: 4 Dim.: M12x25mm 	Pos. 11 Name: Nut 8 B Quantity: 3 Dim.: M10 	Pos. 16 Name: Body of the automat Quantity: 1 
Pos. 3 Name: Socket plate Quantity: 1 	Pos. 7 Name: Bolt 8,8 B Quantity: 1 Dim.: M10x100mm 	Pos. 12 Name: Plain washer Quantity: 4 Dim.: $\varnothing 13 \text{ mm}$ 	Pos. 17 Name: Body plug Quantity: 1 
Pos. 4 Name: Fish-plate with nuts Quantity: 2 	Pos. 8 Name: Bolt 8,8 B Quantity: 6 Dim.: M10x35mm 	Pos. 13 Name: Plain washer Quantity: 7 Dim.: $\varnothing 10,5 \text{ mm}$ 	Pos. 18 Name: Ball cover Quantity: 1 
	Pos. 9 Name: Truncate washer Quantity: 2 Dim.: $\varnothing 58 \times \varnothing 13 \times 6 \text{mm}$ 	Pos. 14 Name: Spring washer Quantity: 4 Dim.: $\varnothing 12,2 \text{ mm}$ 	



PPUH AUTO-HAK Sp.J.

Produkcja Zaczepów Kulowych
Henryk & Zbigniew Nejman
76-200 SŁUPSK ul. Słoneczna 16K
tel/fax (059) 8-414-414; 8-414-413
E-mail: office@autohak.com.pl
www.autohak.com.pl

Towing hitch (without electrical set)

Class: **A50-X** Cat. no. **Y29A**

Designed for:

Manufacturer: **HONDA**

Model: **HR-V**

Type: **3-5 doors**

produced since 06.2002 till 2006

Technical data:

D-value: 6,83 kN

maximum trailer weight: **1200 kg**

maximum vertical cup load: **60 kg**

Approval number according to Directive 94/20/EC: **e20*94/20*1012*00**

Foreword

This towbar is designed according to rules of safety traffic regulations. The towing hitch is a safety component and can be install only by qualified personnel. Any alteration or conversion of the towing hitch is prohibited and would lead to cancellation of design certification. Remove insulating compound and underseal from vehicle (if present) in the area of the matting surfaces of the towing hitch.

The vehicle manufacturer's specifications regarding trailer load and max. vertical cup load are decisive for driving, and values for the towing hitch cannot be exceeded.

D-value formula:

$$\frac{\text{Max trailer weight [kg]} \times \text{Max vehicle weight [kg]}}{\text{Max trailer weight [kg]} + \text{Max vehicle weight [kg]}} \times \frac{9,81}{1000} = D \text{ [kN]}$$